



Above and Below Ground Drainage

PRICE GUIDE

TPL50 - May 2016



Including...



UNDERGROUND SYSTEMS



	Page
Drains	75
Fittings	76
Hoppers	83
Chambers	85
Sewers	89
Structured Wall	91

RAINWATER SYSTEMS



	Page
For average UK roof sizes	05
For large UK roof sizes	15
Cast Iron Effect	23
For super UK roof sizes	29
Brackets & Ancillaries	37
Innovations	39
For flat roofs	40
Ease of Installation	41

MULTIKWIK SYSTEMS



	Page
Traps	101
Ventilation & Accessories	105
Waste	109
WC Connectors	113
Concealed Cisterns	121
Valves	121
Sanitary Systems	124
Floor Drainage	128

SOIL & WASTE SYSTEMS



	Page
Pushfit & Solvent Soil	45
WC Connectors	57
Fire Protection	60
Cast Iron Effect	61
Waste	63
Overflow	69
Grease Management	71
Pipe Carrier	72

THE BENEFITS OF A SERIOUSLY **GOOD** SERVICE

Welcome to your Hunter price guide.

I'm Joe and I'm here to help you through the price guide.

It's packed full of useful content and images to make your product selection easier.

Every page has been designed to be as informative and easy to use as possible as we make every effort to continue our 'seriously good' service.

Joe



PS: We would love to know what you think, so if you have any comments or suggestions on how we can continue improving our guide drop us an email at: marketing@hunterplastics.co.uk

HERE TO HELP...

Keep your eyes peeled for my handy hints and tips throughout - there's some real gems that might save you time and money.

How can you spot them? It's easy just look for one of these symbols.

Plus, in the bottom right corner of most pages you'll find a handy colour reference key to make selecting your product even easier.



GOOD TO GO

It's doing the simple things well, that sets us apart. We listen and we know what you want. You want easy access to us, you have it.

You want peace of mind with the products you use, you have it. You want the products when you ask for them, you have it.

1

GOOD CALL

For immediate access to
SALES
01622 852654
TECHNICAL
01622 852798



2

GOOD QUALITY

Products made under
ISO9001 coupled with a
GOOD mix of 3rd Party Approvals.



3

GOOD DELIVERY

Award winning delivery
service you can trust in.



WE GIVE A SIMPLE AND HONEST SERVICE, WHICH MEANS YOU'RE **GOOD** TO GO.



RAINWATER SYSTEMS

For average UK roof sizes...

Half Round

There's two - Standard & Mini

Flow Rate
Up to 2.6l/s



p5

Squareflo

The 'Box' One

Flow Rate
Up to 3.8l/s



p11

For large UK roof sizes...

125

A Deeper Profile

Flow Rate
Up to 4.9l/s

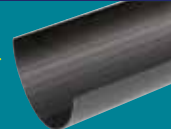

p15

Regency

For Style & Volume

Flow Rate
Up to 4.7l/s

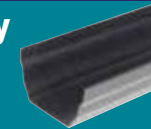

p19

Cast Iron Effect..

Foundry Finish

A Cast Iron look without the expense

p23

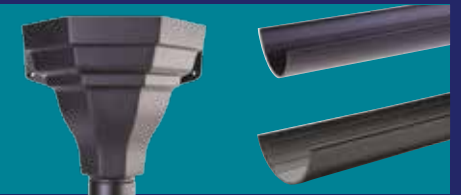

For super UK roof sizes...

Highflo

For Great Volumes

Flow Rate
Up to 6.0l/s

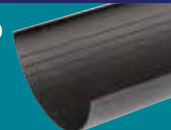

p29

Stormflo

The Big One

Flow Rate
Up to 14.0l/s



p33

For flat roofs...

Roof Outlets

For Flat Roofs

p40



To help get the job done...

Brackets & Ancillaries



p37

Innovations



p39

Ease of Installation



p41



A Standard Profile

HALF ROUND

112mm SUREFIT GUTTER SYSTEM

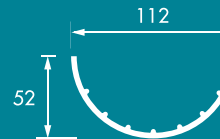

Flow Rate
Up to
2.6l/s

Packed with more benefits than you can imagine. With a flow rate of up to 2.6l/s it's **GOOD** for average UK roof sizes.



GUTTER



	Code	Pack	£.Each
2 metre	GR511	10	£18.60
	BR511	10	£18.60
	VR511	10	£18.60
	WR511	10	£18.60
4 metre	GR512	5	£35.50
	BR512	5	£35.50
	VR512	5	£35.50
	WR512	5	£35.50
5 metre	BR552	5	£44.38

SUPPORT BRACKET

1 screw fixing

Fix at 1m centres - max

Code	Pack	£.Each
GR010	20	£3.08
BR010	20	£3.08
VR010	20	£3.08
WR010	20	£3.08

SUPPORT BRACKET

2 screw fixing

Fix at 1m centres - max

Code	Pack	£.Each
GR025	20	£4.15
BR025	20	£4.15
VR025	20	£4.15
WR025	20	£4.15

RUNNING OUTLET

Code	Pack	£.Each
GR011	5	£10.35
BR011	5	£10.35
VR011	5	£10.35
WR011	5	£10.35

STOPEND OUTLET

Code	Pack	£.Each
GR012	5	£10.35
BR012	5	£10.35
VR012	5	£10.35
WR012	5	£10.35

UNION

Code	Pack	£.Each
GR398	10	£8.09
BR398	10	£8.09
VR398	10	£8.09
WR398	10	£8.09

JOINT BRACKET

Code	Pack	£.Each
GR008	10	£6.24
BR008	10	£6.24
VR008	10	£6.24
WR008	10	£6.24

EXTERNAL STOPEND

Code	Pack	£.Each
GR013	10	£5.28
BR013	10	£5.28
VR013	10	£5.28
WR013	10	£5.28

90° ANGLE

See page 95 for special fabrications.

Code	Pack	£.Each
GR005	5	£11.55
BR005	5	£11.55
VR005	5	£11.55
WR005	5	£11.55

120° ANGLE

Code	Pack	£.Each
BR006	5	£12.44
VR006	5	£12.44
WR006	5	£12.44

135° ANGLE

Code	Pack	£.Each
GR007	5	£12.44
BR007	5	£12.44
VR007	5	£12.44
WR007	5	£12.44

CONNECTION TO CAST IRON

Code	Pack	£.Each	
HR/CI Gutter	BR459	1	£12.32
HR/CI Gutter	WR459	1	£12.32
HR/ogee - RH	BR461	1	£16.93
HR/ogee - LH	BR462	1	£16.93

GUTTER LEAF GUARD

For 112mm Half Round and Squareflo

Code	Pack	£.Each
R500	1	£27.55

5 metre pack (10 x 500mm).

GOOD TO KNOW

ACCESSORIES/SPARES AVAILABLE

Rise & Fall Brackets p37

Spare Seals p38

For 112mm Half Round and Squareflo

Code Pack £.Each

R500 1 £27.55

5 metre pack (10 x 500mm).

Each product code is prefixed with a colour.

Example BR125, where 'B' = BLACK

GREY (G) BLACK (B) BROWN (V) WHITE (W)

HALF ROUND FOR AVERAGE ROOFS

DOWNPIPE



Code Pack £.Each

2 metre	GR518	5	£18.83
	BR518	5	£18.83
	VR518	5	£18.83
	WR518	5	£18.83
2.5 metre	GR519	5	£23.65
	BR519	5	£23.65
	VR519	5	£23.65
	WR519	5	£23.65
4 metre	GR520	5	£37.61
	BR520	5	£37.61
	VR520	5	£37.61
	WR520	5	£37.61
5.5 metre	GR521	5	£51.86
	BR521	5	£51.86
	VR521	5	£51.86
	WR521	5	£51.86

CONNECTOR



Code Pack £.Each

GR017	10	£5.30
BR017	10	£5.30
VR017	10	£5.30
WR017	10	£5.30

112½° BRANCH



Code Pack £.Each

GR022	5	£20.90
BR022	5	£20.90
VR022	5	£20.90
WR022	5	£20.90

ADJUSTABLE OFFSET



Min: 22mm Max: 80mm.

Code Pack £.Each

BR024	5	£14.26
VR024	5	£14.26
WR024	5	£14.26

ACCESS PIPE



Code Pack £.Each

GR001	1	£42.49
BR001	1	£42.49
VR001	1	£42.49
WR001	1	£42.49

SQUARE/ROUND ADAPTOR



Code Pack £.Each

BR397	5	£11.00
VR397	5	£11.00
WR397	5	£11.00

BRACKET



1 screw fixing

Fix at 2m centres - max

Code Pack £.Each

GR019	10	£4.83
BR019	10	£4.83
VR019	10	£4.83
WR019	10	£4.83

BRACKET



2 screw fixing

Fix at 2m centres - max

Code Pack £.Each

GR046	10	£4.70
BR046	10	£4.70
VR046	10	£4.70
WR046	10	£4.70

REDUCER



68mm Socket to 110mm Spigot.

Code Pack £.Each

BR768	10	£7.58
-------	----	-------

REDUCER



82mm Spigot to 68mm Socket.

Code Pack £.Each

GR004	5	£7.73
-------	---	-------

REDUCER



110mm Socket to 68mm Socket.

Code Pack £.Each

BR003	5	£7.65
-------	---	-------

92½° BEND



Code Pack £.Each

GR577	10	£10.39
BR577	10	£10.39
VR577	10	£10.39
WR577	10	£10.39

112½° OFFSET BEND



Code Pack £.Each

GR020	10	£7.88
BR020	10	£7.88
VR020	10	£7.88
WR020	10	£7.88

SHOE



Code Pack £.Each

GR021	10	£7.32
BR021	10	£7.32
VR021	10	£7.32
WR021	10	£7.32

HOPPER HEAD



Code Pack £.Each

GR014	1	£33.26
BR014	1	£33.26
VR014	1	£33.26
WR014	1	£33.26

DRAIN CONNECTOR



External use only

Code Pack £.Each

DS024	1	£24.04
-------	---	--------

Flexible for 50, 65 and 68mm.

GOOD TO KNOW

Want an easy installation? Check out our ADJUSTABLE OFFSET and QUICK FIX CLIPS p41

G GREY
 B BLACK
 V BROWN
 W WHITE

Each product code is prefixed with a colour. Example BR125, where 'B' = BLACK



The Mini One

HALF ROUND

76mm GUTTER SYSTEM

50mm PIPES AND FITTINGS

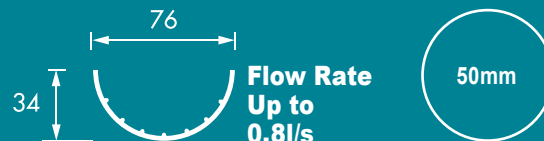

GUTTER



	Code	Pack	£.Each
2 metre	GR513	10	£18.49
	BR513	10	£18.49
	VR513	10	£18.49
	WR513	10	£18.49

JOINT BRACKET



	Code	Pack	£.Each
	GR037	10	£4.84
	BR037	10	£4.84
	VR037	10	£4.84
	WR037	10	£4.84

SUPPORT BRACKET

1 screw fixing



Fix at 1m centres - max

	Code	Pack	£.Each
	GR036	20	£1.84
	BR036	20	£1.84
	VR036	20	£1.84
	WR036	20	£1.84

DOWNPIPE



	Code	Pack	£.Each
2 metre	GR522	10	£24.33
	BR522	10	£24.33
	VR522	10	£24.33
	WR522	10	£24.33

BRACKET

1 screw fixing



Fix at 2m centres - max

	Code	Pack	£.Each
	GR039	10	£3.29
	BR039	10	£3.29
	VR039	10	£3.29
	WR039	10	£3.29

112° OFFSET BEND



	Code	Pack	£.Each
	GR040	10	£8.55
	BR040	10	£8.55
	VR040	10	£8.55
	WR040	10	£8.55

90° ANGLE

See page 95 for special fabrications.



	Code	Pack	£.Each
	GR029	5	£9.47
	BR029	5	£9.47
	VR029	5	£9.47
	WR029	5	£9.47

135° ANGLE



	Code	Pack	£.Each
	GR031	5	£9.47
	BR031	5	£9.47
	VR031	5	£9.47
	WR031	5	£9.47

EXTERNAL STOPEND



	Code	Pack	£.Each
	GR034	10	£3.36
	BR034	10	£3.36
	VR034	10	£3.36
	WR034	10	£3.36

DRAIN LEAF GUARD



Covers drains 300mm wide x 265mm

	Code	Pack	£.Each
	DS500	15	£17.17

Accepts downpipe up to 110mm.

CONNECTOR



	Code	Pack	£.Each
	GR038	5	£5.19
	BR038	5	£5.19
	VR038	5	£5.19
	WR038	5	£5.19

SHOE



	Code	Pack	£.Each
	GR041	5	£7.32
	BR041	5	£7.32
	VR041	5	£7.32
	WR041	5	£7.32

RUNNING OUTLET



	Code	Pack	£.Each
	GR032	5	£9.47
	BR032	5	£9.47
	VR032	5	£9.47
	WR032	5	£9.47

STOPEND OUTLET



	Code	Pack	£.Each
	GR033	5	£9.44
	BR033	5	£9.44
	VR033	5	£9.44

GOOD TO KNOW

ACCESSORIES AVAILABLE

Lubricants p38
Silicone Spray p38



Each product code is prefixed with a colour.

Example BR125, where 'B' = BLACK

REDUCER



68mm Spigot to 50mm Spigot.

	Code	Pack	£.Each
	GR666	5	£7.68
	BR666	5	£7.68
	WR666	5	£7.68

REDUCER



110mm Spigot x 50mm Socket.

	Code	Pack	£.Each
	GS264	1	£23.08
	WS264	1	£23.08

GOOD TO KNOW

NEED A HOPPER?

Use a R014 112mm Hopper with the R666 Reducer

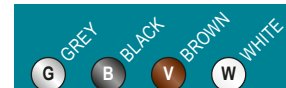

Each product code is prefixed with a colour.

Example BR125, where 'B' = BLACK

HALF ROUND FOR AVERAGE ROOFS



SQUAREFLO

The 'Box' One

114mm SUREFIT GUTTER SYSTEM

Squareflo's simple style perfectly complements uPVC windows and conservatories. With a flow rate of up to 3.8l/s it's **GOOD** for average UK roof sizes.



Flow Rate
Up to
3.8l/s

GUTTER



	Code	Pack	£.Each
2 metre	BR516	10	£19.06
	VR516	10	£19.06
	WR516	10	£19.06
4 metre	BR517	5	£36.56
	VR517	5	£36.56
	WR517	5	£36.56
5 metre	WR557	5	£45.67

SUPPORT BRACKET

1 screw fixing



Fix at 1m centres - max

Code	Pack	£.Each
BR378	10	£3.08
VR378	10	£3.08
WR378	10	£3.08

SUPPORT BRACKET

2 screw fixing



Fix at 1m centres - max

Code	Pack	£.Each
BR395	20	£4.15
VR395	20	£4.15
WR395	20	£4.15

JOINT BRACKET



Code	Pack	£.Each
BR379	10	£6.24
VR379	10	£6.24
WR379	10	£6.24

CONNECTOR TO HR/CI



Code	Pack	£.Each
BR387	5	£12.32
VR387	5	£12.32
WR387	5	£12.32

RUNNING OUTLET



Code	Pack	£.Each
BR376	5	£10.35
VR376	5	£10.35
WR376	5	£10.35

STOPEND OUTLET



Code	Pack	£.Each
BR394	5	£10.35
VR394	5	£10.35
WR394	5	£10.35

EXTERNAL STOPEND



Code	Pack	£.Each
BR380	10	£5.28
VR380	10	£5.28
WR380	10	£5.28

INTERNAL STOPEND



Only suitable for fittings with seals.

Code	Pack	£.Each
BR381	5	£2.70
VR381	5	£2.70
WR381	5	£2.70

90° ANGLE

See page 95 for special fabrications.



Code	Pack	£.Each
BR383	5	£11.55
VR383	5	£11.55
WR383	5	£11.55

120° ANGLE



Code	Pack	£.Each
BR374	5	£12.44
VR374	5	£12.44
WR374	5	£12.44

135° ANGLE



Code	Pack	£.Each
BR375	5	£12.44
VR375	5	£12.44
WR375	5	£12.44

150° ANGLE



Code	Pack	£.Each
VR370	5	£14.98
WR370	5	£14.98

GOOD TO KNOW

ACCESSORIES/SPARES AVAILABLE
Rise & Fall Brackets p37
Spare Seals p38

BLACK BROWN WHITE

B **V** **W**

Each product code is prefixed with a colour.
Example BR125, where 'B' = BLACK

DOWNPIPE



	Code	Pack	£.Each
2.5 metre	BR525	6	£23.65
	VR525	6	£23.65
	WR525	6	£23.65
4 metre	BR526	6	£37.61
	VR526	6	£37.61
	WR526	6	£37.61
5.5 metre	BR320	4	£51.86
	VR320	4	£51.86
	WR320	4	£51.86

BRACKET

2 screw fixing

Fix at 2m centres - max

	Code	Pack	£.Each
Stand off	BR388	10	£4.70
	VR388	10	£4.70
	WR388	10	£4.70

BRACKET

2 screw fixing

Fix at 2m centres - max

	Code	Pack	£.Each
Close to wall	BR373	10	£4.83
	VR373	10	£4.83
	WR373	10	£4.83

BRACKET

1 screw fixing

Fix at 2m centres - max

	Code	Pack	£.Each
BR371	BR371	10	£4.83
	VR371	10	£4.83
	WR371	10	£4.83

CONNECTOR

	Code	Pack	£.Each
BR389	BR389	5	£5.30
	VR389	5	£5.30
	WR389	5	£5.30

ADJUSTABLE OFFSET

Min: 25mm Max: 65mm.

	Code	Pack	£.Each
BR399	BR399	5	£14.26
	VR399	5	£14.26
	WR399	5	£14.26

112½° BRANCH

	Code	Pack	£.Each
BR392	BR392	5	£20.90
	VR392	5	£20.90
	WR392	5	£20.90

HOPPER HEAD

	Code	Pack	£.Each
BR014	BR014	1	£33.26
	VR014	1	£33.26
	WR014	1	£33.26

ACCESS PIPE

COMPLIANT - BUILDING REGULATIONS PART H

	Code	Pack	£.Each
VR301	VR301	1	£43.22
	WR301	1	£43.22

SQUARE/ROUND ADAPTOR

65mm square x 68mm circular.

	Code	Pack	£.Each
BR397	BR397	5	£11.00
	VR397	5	£11.00
	WR397	5	£11.00

SWIVEL ADAPTOR

	Code	Pack	£.Each
BR396	BR396	5	£11.00
	VR396	5	£11.00
	WR396	5	£11.00

92½° BEND

	Code	Pack	£.Each
BR393	BR393	5	£10.39
	VR393	5	£10.39
	WR393	5	£10.39

112½° OFFSET BEND

	Code	Pack	£.Each
BR390	BR390	5	£7.88
	VR390	5	£7.88
	WR390	5	£7.88

SHOE

	Code	Pack	£.Each
BR391	BR391	5	£7.32
	VR391	5	£7.32
	WR391	5	£7.32

GOOD TO KNOW

Install a Uni-Fit Outlet (p20) and position your downpipe anywhere you want!

Perfect for conservatories where there are lots of windows to avoid!



GOOD TIP

The Swivel Adaptor allows Offset Bends to 'swivel' in any direction, ideal for misaligned drainage points.

BLACK B BROWN V WHITE W

Each product code is prefixed with a colour.
Example BR125, where 'B' = BLACK



125

A Deeper Profile

125mm SUREFIT GUTTER SYSTEM

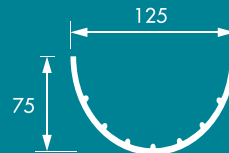

Flow Rate
Up to
4.9l/s

With Surefit strength and a volume you can trust, 125 is **GOOD** for large UK roof sizes. Plus you can increase the volume even more by installing the superior 82mm downpipe system.



GUTTER



	Code	Pack	£.Each
4 metre	GR640	5	£44.46
	BR640	5	£44.46
	VR640	5	£44.46
	WR640	5	£44.46

JOINT BRACKET



	Code	Pack	£.Each
	GR608	10	£9.18
	BR608	10	£9.18
	VR608	10	£9.18
	WR608	10	£9.18

SUPPORT BRACKET

2 screw fixing



Fix at 800mm centres - max

	Code	Pack	£.Each
	GR610	20	£3.71
	BR610	20	£3.71
	VR610	20	£3.71
	WR610	20	£3.71

90° EXTERNAL ANGLE

See page 95 for special fabrications.



	Code	Pack	£.Each
	GR605	5	£13.56
	BR605	5	£13.56
	VR605	5	£13.56
	WR605	5	£13.56

90° INTERNAL ANGLE



	Code	Pack	£.Each
	GR615	5	£13.56
	BR615	5	£13.56
	VR615	5	£13.56
	WR615	5	£13.56

135° EXTERNAL ANGLE



	Code	Pack	£.Each
	GR607	5	£14.50
	BR607	5	£14.50
	VR607	5	£14.50
	WR607	5	£14.50

135° INTERNAL ANGLE



	Code	Pack	£.Each
	GR617	5	£14.50
	BR617	5	£14.50
	VR617	5	£14.50
	WR617	5	£14.50

68mm RUNNING OUTLET



	Code	Pack	£.Each
	GR611	5	£13.06
	BR611	5	£13.06
	VR611	5	£13.06
	WR611	5	£13.06

82mm RUNNING OUTLET



	Code	Pack	£.Each
	GR682	5	£13.06
	BR682	5	£13.06
	VR682	5	£13.06
	WR682	5	£13.06

EXTERNAL STOPEND



	Code	Pack	£.Each
	GR613	10	£6.30
	BR613	10	£6.30
	VR613	10	£6.30
	WR613	10	£6.30

INTERNAL STOPEND



	Code	Pack	£.Each
	GR602	10	£3.54
	BR602	10	£3.54
	VR602	10	£3.54
	WR602	10	£3.54

ADAPTOR SEAL



	Code	Pack	£.Each
	GR600	5	£10.05

Replaces standard seal. Allows connection to most deep profile systems.



GOOD TO KNOW

The slotted fixing points on 125 angles mean you can fix directly to the fascia and they can be adjusted too!
Less brackets - less fuss!



GOOD TO KNOW

125 brackets are super strong, they can hold up to 75kg!



Each product code is prefixed with a colour.

Example BR125, where 'B' = BLACK

125 FOR LARGE ROOFS

DOWNPIPE



Code Pack £.Each

2 metre	GR518	5	£18.83
	BR518	5	£18.83
	VR518	5	£18.83
	WR518	5	£18.83
2.5 metre	GR519	5	£23.65
	BR519	5	£23.65
	VR519	5	£23.65
	WR519	5	£23.65
4 metre	GR520	5	£37.61
	BR520	5	£37.61
	VR520	5	£37.61
	WR520	5	£37.61
5.5 metre	GR521	5	£51.86
	BR521	5	£51.86
	VR521	5	£51.86
	WR521	5	£51.86

BRACKET



Fix at 2m centres - max

Code Pack £.Each

	GR019	10	£4.83
	BR019	10	£4.83
	VR019	10	£4.83
	WR019	10	£4.83

BRACKET



Fix at 2m centres - max

Code Pack £.Each

	GR046	10	£4.70
	BR046	10	£4.70
	VR046	10	£4.70
	WR046	10	£4.70

CONNECTOR



Code Pack £.Each

	GR017	10	£5.30
	BR017	10	£5.30
	VR017	10	£5.30
	WR017	10	£5.30

92½° BEND



Code Pack £.Each

	GR577	10	£10.39
	BR577	10	£10.39
	VR577	10	£10.39
	WR577	10	£10.39

112½° OFFSET BEND



Code Pack £.Each

	GR020	10	£7.88
	BR020	10	£7.88
	VR020	10	£7.88
	WR020	10	£7.88

SHOE



Code Pack £.Each

	GR021	10	£7.32
	BR021	10	£7.32
	VR021	10	£7.32
	WR021	10	£7.32

112½° BRANCH



Code Pack £.Each

	GR022	5	£20.90
	BR022	5	£20.90
	VR022	5	£20.90
	WR022	5	£20.90

DOWNPIPE



Code Pack £.Each

4 metre	GR700	5	£37.61
	BR700	5	£37.61
	VR700	5	£37.61
	WR700	5	£37.61

BRACKET



Fix at 2m centres - max

Code Pack £.Each

	GS612	10	£4.89
	BS612	10	£4.89
	VS612	10	£4.89
	WS612	10	£4.89

CONNECTOR



Code Pack £.Each

	GR717	5	£5.30
	BR717	5	£5.30
	VR717	5	£5.30
	WR717	5	£5.30

112½° OFFSET BEND



Code Pack £.Each

	GR720	6	£8.09
	BR720	6	£8.09
	VR720	6	£8.09
	WR720	6	£8.09

SHOE



Code Pack £.Each

	GR721	5	£7.32
	BR721	5	£7.32
	VR721	5	£7.32
	WR721	5	£7.32

112½° BRANCH



Code Pack £.Each

	GR722	5	£22.58
	BR722	5	£22.58
	VR722	5	£22.58
	WR722	5	£22.58

REDUCER



82mm Spigot to 68mm Socket.

Code Pack £.Each

	GR004	5	£7.73
--	-------	---	-------

GOOD TIP



Replace your 68mm downpipe with 82mm (using the R682) to drain bigger roofs with fewer outlets

JOBS A GOOD'UN™

GOOD TO KNOW



ACCESSORIES/SPARES AVAILABLE
Rise & Fall Brackets p37
Spare Seals p38



Each product code is prefixed with a colour.

Example BR125, where 'B' = BLACK



REGENCY

For Style & Volume

125mm SUREFIT GUTTER SYSTEM

Designed to add a touch of elegance to any modern or period style buildings. Regency offers a flow rate of up to 4.7l/s – a **GOOD** choice for large roof areas.

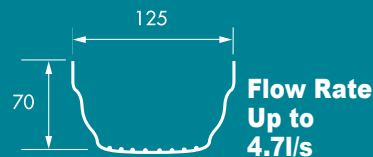

GUTTER



	Code	Pack	£.Each
4 metre	BR896	5	£56.64
	VR896	5	£56.64
	WR896	5	£56.64

JOINT BRACKET



	Code	Pack	£.Each
	BR908	5	£14.96
	VR908	5	£14.96
	WR908	5	£14.96

SUPPORT BRACKET



	Code	Pack	£.Each
	BR910	20	£5.61
	VR910	20	£5.61
	WR910	20	£5.61

EXTERNAL STOPEND



	Code	Pack	£.Each
	BR913	5	£7.69
	VR913	5	£7.69
	WR913	5	£7.69

INTERNAL STOPEND



	Code	Pack	£.Each
	BR902	5	£4.36
	VR902	5	£4.36
	WR902	5	£4.36

LONG EXTERNAL STOPEND



	Code	Pack	£.Each
	BR914	5	£8.38
	VR914	5	£8.38
	WR914	5	£8.38

90° EXTERNAL ANGLE

See page 95 for special fabrications.



	Code	Pack	£.Each
	BR935	5	£18.82
	VR935	5	£18.82
	WR935	5	£18.82

90° INTERNAL ANGLE



	Code	Pack	£.Each
	BR945	5	£18.82
	VR945	5	£18.82
	WR945	5	£18.82

RUNNING OUTLET



Patented.			
	Code	Pack	£.Each
	BR911	10	£20.06
	VR911	10	£20.06
	WR911	10	£20.06

135° EXTERNAL ANGLE



	Code	Pack	£.Each
	BR937	5	£20.56
	VR937	5	£20.56
	WR937	5	£20.56

135° INTERNAL ANGLE



	Code	Pack	£.Each
	BR947	5	£20.56
	VR947	5	£20.56
	WR947	5	£20.56

UNIFIT OUTLET



	Code	Pack	£.Each
	BR400	10	£10.48
	VR400	10	£10.48
	WR400	10	£10.48

Use a 57mm hole cutter. Outlet suitable for 68mm Round, Squareflo or Regency pipes.



The external 'Insert to Here' lines on Regency gutter fittings make it easier to install your gutter to the correct position – without having to look over the top of your gutter!

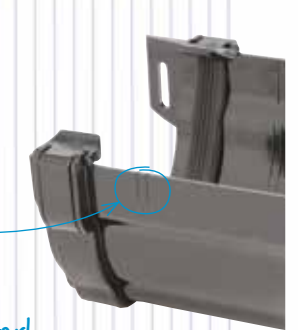

GOOD TO KNOW

ACCESSORIES/SPARES AVAILABLE

Rise & Fall Brackets p37

Spare Seals p38

BLACK BROWN WHITE

B V W

Each product code is prefixed with a colour.

Example BR125, where 'B' = BLACK



REGENCY

74mm

74mm PIPES AND FITTINGS

DOWNPIPE



Code Pack £.Each

4 metre	BR893	6	£63.71
	VR893	6	£63.71
	WR893	6	£63.71

BRACKET



2 screw fixing

Fix at 2m centres - max

Code Pack £.Each

	BR919	10	£6.08
	VR919	10	£6.08
	WR919	10	£6.08

5mm BRACKET SPACER



Code Pack £.Each

	VR927	50	£1.56
--	-------	----	-------

CONNECTOR



Code Pack £.Each

	BR917	5	£14.98
	VR917	5	£14.98
	WR917	5	£14.98

112½° BEND



Code Pack £.Each

	BR920	5	£12.99
	VR920	5	£12.99
	WR920	5	£12.99

112½° BRANCH



Code Pack £.Each

	BR922	5	£37.94
	VR922	5	£37.94
	WR922	5	£37.94

SHOE



Code Pack £.Each

	BR921	5	£12.31
	VR921	5	£12.31
	WR921	5	£12.31

REGENCY TO 68mm REDUCER



Code Pack £.Each

	BR924	5	£12.10
	VR924	5	£12.10
	WR924	5	£12.10

HOPPER HEAD



Code Pack £.Each

	BR014	1	£33.26
	VR014	1	£33.26
	WR014	1	£33.26

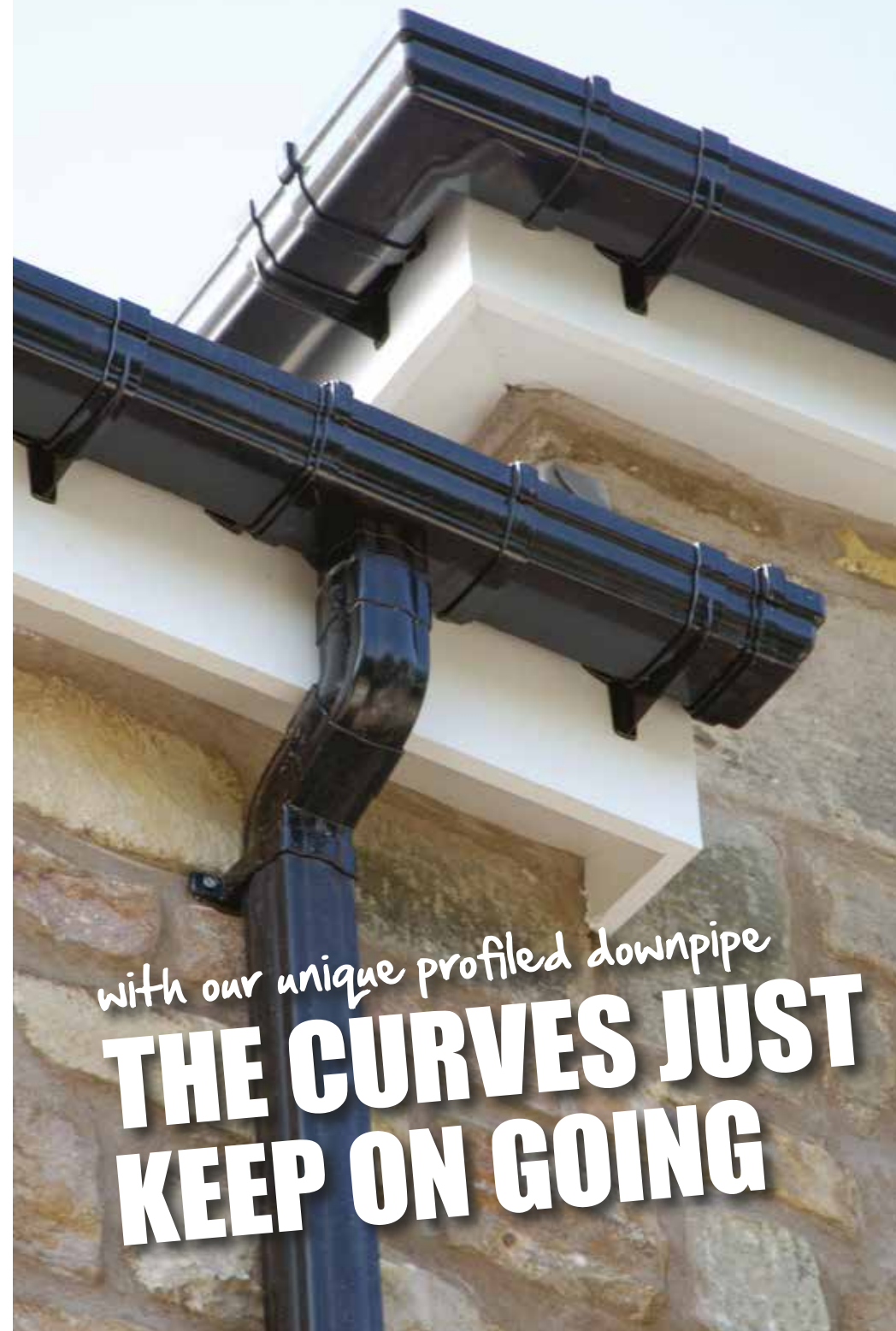

with our unique profiled downpipe
THE CURVES JUST KEEP ON GOING

HEY
GOOD LOOKIN

A CAST IRON
LOOK WITHOUT THE EXPENSE

Half Round

The standard one



p25

125

The deeper profile

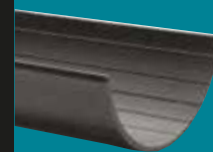

p26

Foundry
Finish Soil



p61

FOUNDRIY FINISH





HALF ROUND

FOUNDRY FINISH - 112mm SUREFIT GUTTER SYSTEM



125

FOUNDRY FINISH - 125mm SUREFIT GUTTER SYSTEM

GUTTER



Code Pack £.Each

4 metre CBR512 5 £67.90

JOINT BRACKET



Code Pack £.Each

CBR008 10 £18.49

SUPPORT BRACKET



1 screw fixing

Fix at 1m centres - max

Code Pack £.Each

CBR010 20 £4.28

GUTTER



Deep profile

Code Pack £.Each

4 metre CBR640 5 £82.53

JOINT BRACKET



Code Pack £.Each

CBR608 10 £22.47

SUPPORT BRACKET



2 screw fixing

Fix at 1m centres - max

Code Pack £.Each

CBR610 20 £5.19

90° ANGLE

See page 95 for special fabrications.



Code Pack £.Each

CBR005 5 £24.75

135° ANGLE



Code Pack £.Each

CBR007 5 £25.70

RUNNING OUTLET



Code Pack £.Each

CBR011 5 £24.14

90° EXTERNAL ANGLE

See page 95 for special fabrications.



Code Pack £.Each

CBR605 5 £30.08

90° INTERNAL ANGLE



Code Pack £.Each

CBR615 5 £30.08

STOPEND



NB: Internal Stopend shown

Code Pack £.Each

Internal CBR602 10 £15.23

External CBR613 10 £15.23

EXTERNAL STOPEND



Code Pack £.Each

CBR013 5 £12.54



GOOD TO KNOW

Make installation even easier!
Apply a small amount of Hunter silicone lubricant onto the seals of your joint brackets, outlets and angles.



135° EXTERNAL ANGLE



Code Pack £.Each

CBR607 5 £31.25

135° INTERNAL ANGLE



Code Pack £.Each

CBR617 5 £31.25

RUNNING OUTLET



Code Pack £.Each

CBR611 5 £29.33

Fits 68mm pipe.



PIPES & FITTINGS

FOUNDRY FINISH
- 68mm

DOWNPIPE



Code Pack £.Each

2.75 metre CBR519 5 £62.71

EARED PIPE CONNECTOR



Code Pack £.Each

CBR017 10 £18.71

EARED PIPE BRACKET



2 screw fixing

Fix at 2m centres - max

Code Pack £.Each

CBR043 10 £10.04

92½° BEND



Code Pack £.Each

CBR577 10 £26.69

112½° BEND



Code Pack £.Each

CBR020 10 £32.02

112½° BRANCH



Code Pack £.Each

CBR022 5 £57.29

EARED SHOE



Code Pack £.Each

CBR021 5 £38.36

CURVED HOPPER HEAD



Code Pack £.Each

CBR044 1 £62.96

COACH BOLTS FIXINGS



Pack of 10

Code Pack £.Each

CBF001 £7.88



Supersize rainwater profiles
**FOR WHEN BIG
ISN'T BIG ENOUGH...**



For Great Volumes

HIGHFLO

170mm GUTTER SYSTEM

Designed to provide superior drainage with a flow rate of up to 6l/s, Highflo is a **GOOD** choice for super size roofs and commercial buildings.

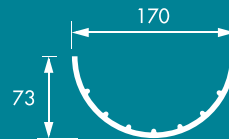

Flow Rate
Up to 6l/s

EXTERNAL STOPEND



Code	Pack	£.Each
GR402	10	£8.29
BR402	10	£8.29
WR402	10	£8.29

UNIFIT OUTLET

For use with flat bottom gutters



Code	Pack	£.Each
GR410	1	£36.26

110mm Spigot.

CHOICE OF COLOURS

& it's super strong too!

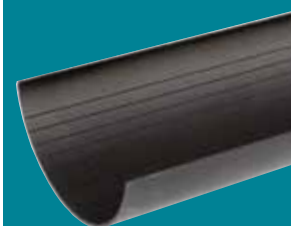
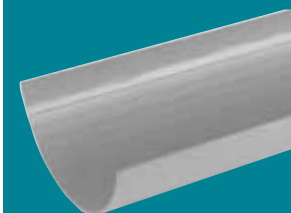

Each product code is prefixed with a colour.

Example BR125, where 'B' = BLACK

GUTTER



	Code	Pack	£.Each
4 metre	GR515	5	£74.15
	BR515	5	£74.15
	WR515	5	£74.15

JOINT BRACKET



	Code	Pack	£.Each
	GR042	10	£9.60
	BR042	10	£9.60
	WR042	10	£9.60

SUPPORT BRACKET

2/3 screw fixing



Fix at 1m centres - max

	Code	Pack	£.Each
	GR452	20	£5.75
	BR452	20	£5.75
	WR452	20	£5.75

90° ANGLE

See page 95 for special fabrications.



	Code	Pack	£.Each
	GR451	1	£24.17
	BR451	1	£24.17
	WR451	1	£24.17

RUNNING OUTLET



	Code	Pack	£.Each
	GR454	1	£18.56
	BR454	1	£18.56
	WR454	1	£18.56

Fits 110mm pipe.

STOPEND OUTLET



	Code	Pack	£.Each
	GR455	1	£17.65
	BR455	1	£17.65

Fits 110mm pipe.

GOOD TO KNOW



PLACE YOUR 110mm DOWNPIPE ANYWHERE!

Threaded outlet



Flat bottom gutter

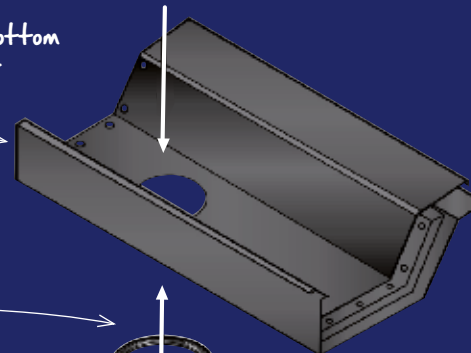

Seal

Spigot suits 110mm socket



Any flat bottom gutter no thicker than 15mm

DOWNPIPE



Code Pack £.Each

3 metre	BS505	1	£54.60
	GS505	1	£54.60
	WS505	1	£54.60
4 metre	BS506	1	£77.36
	GS506	1	£77.36
	WS506	1	£77.36

SOCKETED DOWNPIPE



Code Pack £.Each

3 metre	BS508	1	£59.14
	GS508	1	£59.14
	WS508	1	£59.14

PIPE CONNECTOR



Code Pack £.Each

BS208	1	£15.08
GS208	1	£15.08
WS208	1	£15.08

BRACKET - PIPE



Code Pack £.Each

BS217	10	£5.56
GS217	10	£5.56
WS217	10	£5.56

BRACKET - SOCKET



Code Pack £.Each

Socket	BS220	10	£5.68
	GS220	10	£5.68
	WS220	10	£5.68

DRAIN CONNECTOR



Universal
see p80

Code Pack £.Each

BS121	1	£21.47
GS121	1	£21.47

BRACKET - PIPE



Code Pack £.Each

BS219	10	£5.80
GS219	10	£5.80
WS219	10	£5.80

BRACKET - PIPE/SOCKET



Code Pack £.Each

GS570	5	£11.26
-------	---	--------

Galvanised.

SHOE



Code Pack £.Each

BS266	1	£22.85
GS266	1	£22.85
WS266	1	£22.85

92½° BEND



Code Pack £.Each

BS322	1	£33.74
GS322	1	£33.74
WS322	1	£33.74

135° BEND



Code Pack £.Each

BS331	1	£33.74
GS331	1	£33.74
WS331	1	£33.74

HOPPER HEAD



Code Pack £.Each

BR465	1	£65.44
GR465	1	£65.44
WR465	1	£65.44

112½° TOP OFFSET BEND



Code Pack £.Each

BS270	1	£33.74
GS270	1	£33.74
WS270	1	£33.74

112½° BRANCH



Code Pack £.Each

BS336	1	£50.95
GS336	1	£50.95

ACCESS PIPE



Code Pack £.Each

BS309	1	£52.93
GS309	1	£52.93

112½° BOTTOM OFFSET BEND



Code Pack £.Each

BS271	1	£29.47
GS271	1	£29.47
WS271	1	£29.47

92½° BRANCH



Code Pack £.Each

BS334	1	£49.88
GS334	1	£49.88



The Big One

STORMFLO

200mm GUTTER SYSTEM



One of the biggest PVC rainwater systems around. Stormflo offers an impressive flow rate of up to 14l/s making it a **GOOD** choice for even the largest of roof areas.



GUTTER



	Code	Pack	£.Each
4 metre	GR740	2	£122.80
	BR740	2	£122.80

JOINT BRACKET



	Code	Pack	£.Each
	GR708	6	£35.61
	BR708	6	£35.61

SUPPORT BRACKET



Fix at 800mm centres - max

	Code	Pack	£.Each
	GR710	5	£15.62
	BR710	5	£15.62

RUNNING OUTLET



	Code	Pack	£.Each
	GR711	1	£73.12
	BR711	1	£73.12

Spigot fits 160mm pipe.

90° ANGLE

See page 95 for special fabrications.



	Code	Pack	£.Each
	GR705	1	£110.00
	BR705	1	£110.00

Remember: order 2 Joint Brackets.

135° ANGLE



	Code	Pack	£.Each
	GR707	1	£110.00
	BR707	1	£110.00

Remember: order 2 Joint Brackets.

OUTLET ADAPTOR



Use with a R711 to convert to 110mm downpipe

	Code	Pack	£.Each
	GR716	2	£16.72
	BR716	2	£16.72

For 110mm Highflo downpipes.

EXTERNAL STOPEND



	Code	Pack	£.Each
	GR713	2	£30.49
	BR713	2	£30.49

Remember: order 1 support bracket.



Designed for increased protection against snow loading and wind updrafts

GOOD TO KNOW



Need a Stopend Outlet?



Cut external stopend

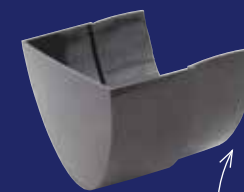

Place into running outlet

JOBS A GOOD'UN™



Each product code is prefixed with a colour.

Example BR125, where 'B' = BLACK



STORMFLO

160mm PIPES AND FITTINGS

160mm

DOWNPIPE



	Code	Pack	£.Each
3 metre	BS534	1	£111.81
	GS534	1	£111.81
4 metre	GS535	1	£147.86

BRACKET - PIPE



	Code	Pack	£.Each
	BS412	10	£12.48
	GS412	10	£12.48

BRACKET - PIPE/SOCKET



	Code	Pack	£.Each
	GS571	5	£20.28
	Galvanised.		

ACCESS PIPE



	Code	Pack	£.Each
	BS472	1	£91.03
	GS472	1	£91.03

92½° BRANCH



	Code	Pack	£.Each
	GS427	1	£140.73
	BS427	1	£140.73

SHOE



	Code	Pack	£.Each
	BS436	1	£67.85
	GS436	1	£67.85

SOCKETED DOWNPIPE



	Code	Pack	£.Each
3 metre	BS533	1	£131.83
	GS533	1	£131.83

92½° BEND



	Code	Pack	£.Each
	BS403	1	£67.85
	GS403	1	£67.85

112½° TOP OFFSET BEND



	Code	Pack	£.Each
	BS424	1	£76.50
	GS424	1	£76.50

112½° BOTTOM OFFSET BEND



	Code	Pack	£.Each
	BS425	1	£76.50
	GS425	1	£76.50

135° BEND



	Code	Pack	£.Each
	BS404	1	£67.85
	GS404	1	£67.85

PIPE CONNECTOR



	Code	Pack	£.Each
	BS406	1	£29.21
	GS406	1	£29.21

GOOD TO KNOW

Offsets

- 1. Push-fit Points up!**
Your push-fit socket should always point upwards.
- 2. Don't screw - glue!**
Secure your solvent sockets with solvent cement.
- 3. Always support!**
Install bracket as close to the offset as possible.

GOOD TIP

Want to connect to 110mm drain?
Use an Outlet Adaptor (R716) to connect Stormflo to 110mm downpipe, see p34

JOBS A GOOD'UN™

REDUCER



	Code	Pack	£.Each
	GS420	1	£49.24

GOOD TIP

Want to connect to 110mm drain?
Use an Outlet Adaptor (R716) to connect Stormflo to 110mm downpipe, see p34

GREY (G) BLACK (B)

Each product code is prefixed with a colour.
Example BR125, where 'B' = BLACK



BRACKETS

ADDITIONAL FIXING BRACKETS

RISE AND FALL BRACKETS



Supplied with 230mm stake

	Code	Pack	£.Each
Squareflo	GR377	25	£13.58
Regency	GR909	25	£13.58
HR 112mm	GR018	25	£13.58
125	GR601	25	£14.01

Remember you'll need one either side of outlets, angles & joint brackets.

LONG RISE/FALL BRACKET



Supplied with 300mm Stake

	Code	Pack	£.Each
HR 112mm	GR009	25	£14.59

VARIABLE RISE /FALL BRACKET



	Code	Pack	£.Each
230mm	BR026	10	£13.17
300mm	BR027	10	£14.65

Including galvanised stake, order gutter bracket separately.

GALVANISED STAKE



	Code	Pack	£.Each
230mm	GR018A	1	£5.53
330mm	GR009A	1	£6.46

WEDGE SPACER



	Code	Pack	£.Each
22½° Pitch	GR002	50	£4.47

Not for use with 170mm Highflo or 200mm Stormflo gutter.

TOP RAFTER BRACKET



	Code	Pack	£.Each
	GR015	25	£9.66

Not for use with 170mm Highflo or 200mm Stormflo gutter.

SIDE RAFTER BRACKET



	Code	Pack	£.Each
	GR016	25	£9.66

Not for use with 170mm Highflo or 200mm Stormflo gutter.

GOOD TIP

Our unique Wedge Space allows your gutter to be installed straight when the fascia is uneven or slanted.

JOBS A GOOD'UN™



SPARES & ANCILLARIES

SPARE RAINWATER SEAL

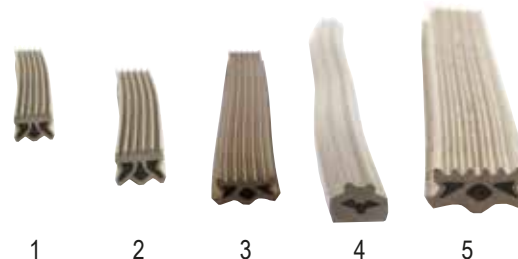

	Code	Pack	£.Each
1. HR 76mm	3SR7601	1	£0.56
2. HR 112mm	3SSI200	1	£0.63
3. Squareflo	3SSI140	1	£0.63
3. 125	3SR1125	1	£0.63
3. Regency	3SR1122A	1	£0.63
4. Highflo	3SR1520	1	£0.85
5. Stormflo	3SRS355	1	£5.67

LUBRICANT



	Code	Pack	£.Each
30ml	SC960	1	£7.48
250ml	SC966	1	£17.80

SILICONE SPRAY



	Code	Pack	£.Each
400ml	SC967	1	£18.24

SOLVENT CLEANER



	Code	Pack	£.Each
125ml	SC950	1	£8.65

SOLVENT CEMENT



BS EN ISO 14680 for PVC.

	Code	Pack	£.Each
125ml	SC953	1	£13.01
250ml	SC954	1	£18.17

UNIVERSAL SILICONE LUBRICANT



We all know lubricant makes installations easier but this makes it even easier still with a built in sponge applicator.

	Code	Pack	£.Each
50g	SC961	1	£10.90



RAINWATER INNOVATIONS

COMPACT RAINWATER GULLY



Accepts 82mm Round, Square or Regency pipes

110mm Inlet/Outlet.

Code Pack £.Each

DS042 6 £51.82

Surface water only. Not for foul water use.

REDUCER



Socket to 110mm Spigot.

Code Pack £.Each

68mm BR768 10 £7.58

82mm BR767 10 £7.65

For use with DS042, Regency or Squareflo.

COURTYARD GULLY



Code Pack £.Each

110mm DCR300 6 £64.49

GUTTER LEAF GUARD



For 112mm Half Round and Squareflo

Code Pack £.Each

R500 1 £27.55

5 metre pack (10 x 500mm).

DRAIN LEAF GUARD



Covers drains 300mm wide x 265mm

Code Pack £.Each

DS500 15 £17.17

Accepts downpipe up to 110mm.

OUTLET LEAF GUARD



Code Pack £.Each

68mm BRV225 20 £5.55

REDUCER



68mm Round or Square pipe to 110mm Spigot

Code Pack £.Each

MKRAB 1 £12.99

UNIFIT OUTLET



For Squareflo & Regency gutter

Code Pack £.Each

68mm BR400 10 £10.48

VR400 10 £10.48

WR400 10 £10.48

Use a 57mm hole cutter. Outlet suitable for 68mm Round, Squareflo or Regency pipes.

UNIFIT OUTLET



For use with flat bottom gutters

Code Pack £.Each

110mm GR410 1 £37.71



For Flat Roofs

ROOF OUTLETS

A **GOOD** cost effective alternative to complicated and expensive metal outlets. Compatible with 3 layer bituminous felt, PVCu roof membranes and hot asphalt.



ROOF OUTLET

Spigot tail



Code Pack £.Each

82mm RV637 1 £103.51

ROOF OUTLET

Spigot tail



Code Pack £.Each

110mm RV369 1 £130.70

ROOF OUTLET

Spigot tail



Code Pack £.Each

160mm RV482 1 £234.72

BALCONY OUTLET

Solvent socket tail



Code Pack £.Each

82mm RV195 1 £167.36

BALCONY OUTLET

Solvent socket tail



Code Pack £.Each

110mm RV196 1 £167.36

BOX GUTTER OUTLET

Spigot tail



Code Pack £.Each

82mm RV491 1 £61.92



TELESCOPIC OFFSET



It's telescopic
Slide to adjust from 140-330mm

Self secures
It grips onto your outlet and will hold up to a 5.5m pipe, no hands!

Safer for working up a ladder
No more juggling products

...no more on-site fabrications to form your offset!

JOBS A GOOD'UN™

	Code	Pack	£.Each
68mm	BR578	5	£22.73

Minimum order quantity 5.

QUICK FIX CLIPS



They're adjustable
With four 5mm offset increments

Easy to align
With plumb and chalk line grooves

The clip is detachable
So it's really easy to remove your downpipe

...and they're designed for drill drivers!

JOBS A GOOD'UN™

	Code	Pack	£.Each
68mm	BR579	£30.26	

Minimum order quantity 5 packs of 5. Fix with countersunk screws.



SOIL AND WASTE

Push-fit & Solvent Soil...

Pipes & Couplings



p45

Bends & Branches



p47

Brackets & Boss Pipes



p51

Adaptors & Reducers



p53

Access & Ventilation



p55

WC Connectors



p57

Cast Iron Effect...

Foundry Finish

A Cast Iron look without the expense

p61



Fire Protection...

Fire Protection

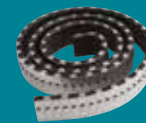

p60

Waste...

Push-fit Waste



p63

Solvent Waste



p65

Overflow



p69

Endura



p71

Grease Management...

Pipe Carrier...

Pipe Carrier



p72



PIPE

82/110/160mm
PUSH-FIT &
SOLVENT

Durable, lightweight and impact resistant, Hunter's Push-fit and Solvent Soil Systems are a **GOOD** reliable way of carrying sanitary waste from domestic, commercial and industrial installations.



PIPE - PLAIN ENDED

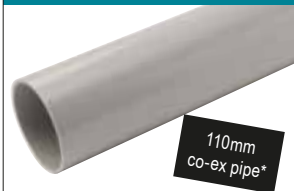

	Code	Pack	£.Each
82mm (3m)	GS599	1	£59.65
	BS599	1	£59.65
110mm (1m)	WS204	1	£21.65
110mm (3m)	GS505	1	£54.60
	BS505	1	£54.60
	WS505	1	£54.60
110mm (4m)	GS506	1	£77.36
	BS506	1	£77.36
	WS506	1	£77.36
160mm (3m)	GS534	1	£111.81
	BS534	1	£111.81
160mm (4m)	GS535	1	£147.86

SOCKETED PIPE



	Code	Pack	£.Each
82mm (3m)	GS602	1	£65.99
82mm (4m)	GS603	1	£85.99
110mm (2m)	GS507	1	£45.25
	BS507	1	£45.25
110mm (3m)	GS508	1	£59.14
	BS508	1	£59.14
	WS508	1	£59.14
110mm (4m)	BS509	1	£82.39
	GS509	1	£82.39
110mm (6m)	BS549	1	£120.03
160mm (3m)	GS533	1	£131.83
	BS533	1	£131.83
160mm (4m)	GS532	1	£167.40
	BS532	1	£167.40
160mm (6m)	GS530	1	£251.22



COUPLING & BENDS

82/110/160mm
PUSH-FIT &
SOLVENT

SINGLE SOCKET

Solvent socket tail



	Code	Pack	£.Each
82mm	GS604	1	£15.49
	BS604	1	£15.49
110mm	GS208	1	£15.08
	BS208	1	£15.08
	WS208	1	£15.08
160mm	GS406	1	£29.21
	BS406	1	£29.21

92½° BEND

Spigot tail



	Code	Pack	£.Each
82mm	GS619	1	£29.89
	BS619	1	£29.89
110mm	GS322	1	£33.74
	BS322	1	£33.74
	WS322	1	£33.74
160mm	GS403	1	£67.85
	BS403	1	£67.85

SLIP COUPLING



	Code	Pack	£.Each
82mm	GS605	1	£25.27
110mm	GS211	1	£24.71
	BS211	1	£24.71
160mm	GS410	1	£47.06

92½° BEND

Solvent socket tail



	Code	Pack	£.Each
110mm	GS319	1	£34.46

92½° BEND

Double solvent socket



	Code	Pack	£.Each
110mm	GS293	1	£31.74
	BS293	1	£31.74
	WS293	1	£31.74

DOUBLE SOCKET



	Code	Pack	£.Each
110mm	GS210	1	£11.88
	BS210	1	£11.88
	WS210	1	£11.88

92½° BEND

Double socket



	Code	Pack	£.Each
110mm	GS671	1	£35.40
	BS671	1	£35.40
	WS671	1	£35.40

SOIL/WASTE FITTINGS GUIDE

- P** Push-fit fittings
- S** Solvent fittings



Each product code is prefixed with a colour.

Example BR125, where 'B' = BLACK

* Co-ex 110mm soil in Grey and Black. See website for more information.
Frame qty: 110mm = 100 / 160mm = 46



BENDS

82/110/160mm PUSH-FIT & SOLVENT

82mm

110mm

160mm

90° LONG BEND

Spigot tail



S	Code	Pack	£.Each
110mm	GS299	1	£28.61
	BS299	1	£28.61
	WS299	1	£28.61

104° BEND

Spigot tail



P	Code	Pack	£.Each
110mm	GS325	1	£34.46

135° BEND

Spigot tail



P	Code	Pack	£.Each
82mm	GS621	1	£29.89
	BS621	1	£29.89
110mm	GS331	1	£33.74
	BS331	1	£33.74
	WS331	1	£33.74
160mm	GS404	1	£67.85
	BS404	1	£67.85

112½° TOP OFFSET BEND

Solvent socket tail



P S	Code	Pack	£.Each
82mm	BS630	1	£29.89
110mm	GS270	1	£33.74
	BS270	1	£33.74
	WS270	1	£33.74
160mm	GS424	1	£76.50
	BS424	1	£76.50

112½° BOTTOM OFFSET BEND

Spigot tail



S	Code	Pack	£.Each
82mm	GS631	1	£29.89
	BS631	1	£29.89
110mm	GS271	1	£29.47
	BS271	1	£29.47
	WS271	1	£29.47
160mm	GS425	1	£76.50
	BS425	1	£76.50

135° BEND

Spigot tail



S	Code	Pack	£.Each
110mm	GS332	1	£28.40
	BS332	1	£28.40

135° BEND

Double solvent socket



S	Code	Pack	£.Each
110mm	GS294	1	£31.74
	BS294	1	£31.74
	WS294	1	£31.74

RING SEAL ADAPTOR

For any solvent sockets



P S	Code	Pack	£.Each
110mm	GS201	10	£6.06
	BS201	10	£6.06

112½° OFFSET BEND

Spigot tail



P	Code	Pack	£.Each
82mm	GS700	1	£29.89
110mm	GS263	1	£34.46
160mm	GS436	1	£67.85
	BS436	1	£67.85

135° OFFSET BEND

Double socket



P	Code	Pack	£.Each
110mm	GS676	1	£35.40
	BS676	1	£35.40
	WS676	1	£35.40

ADJUSTABLE BEND

Spigot tail



Adjusts from 5° - 30°

Twist to lock

P	Code	Pack	£.Each
110mm	GS329	1	£39.40

170° ADAPTOR BEND

Solvent socket tail



P S	Code	Pack	£.Each
110mm	GS324	1	£28.46

160° ADAPTOR BEND

Solvent socket tail



P S	Code	Pack	£.Each
110mm	GS323	1	£28.46

GOOD TIP

Remember to clean your pipe with Solvent Cleaner before applying Solvent Cement.

This ensures a watertight joint by removing all traces of dirt & grease.

JOBS A GOOD'UN™

MULTIFLEX BEND

Spigot tail



Adjusts from 0° - 90°

- One bend covers all angles from 0 to 90°.
- Saving you time and money – you'll never be stuck on site without the correct bend again!

P	Code	Pack	£.Each
110mm	MFBSG	1	£33.21
	MFBSB	1	£33.21

SOIL/WASTE FITTINGS GUIDE

- P** Push-fit fittings
- S** Solvent fittings



Each product code is prefixed with a colour.
Example BR125, where 'B' = BLACK



BRANCHES

82/110/160mm
PUSH-FIT &
SOLVENT

82mm

110mm

160mm

87½° BRANCH

Triple socket



P	Code	Pack	£.Each
110mm	BS672	1	£52.14
	GS672	1	£52.14

92½° BRANCH

Spigot Tail – Bosses Closed



P	Code	Pack	£.Each
82mm	GS611	1	£41.27
3 Boss	BS611	1	£41.27
110mm	GS269	1	£51.59
5 Boss	BS269	1	£51.59
	WS269	1	£51.59

5 BOSS 92½° BRANCH

Solvent Socket Tail



Code	Pack	£.Each	
110mm	GS312	1	£52.70

92½° BRANCH

Socket / spigot tail



P	Code	Pack	£.Each
110mm	GS334	1	£49.88
	BS334	1	£49.88
	WS334	1	£49.88
160mm	GS427	1	£140.73
	BS427	1	£140.73

5 BOSS 92½° BRANCH

Spigot Tail – Bosses Closed



S	Code	Pack	£.Each
110mm	GS302	1	£43.40
	BS302	1	£43.40

3 BOSS 104° BRANCH

Spigot Tail



P	Code	Pack	£.Each
110mm	GS272	1	£52.70
	BS272	1	£52.70

92½° BRANCH

Spigot tail



Code	Pack	£.Each	
110mm	GS297	1	£41.72
	BS297	1	£41.72

5 BOSS 92½° BRANCH

Triple Solvent Socket – Bosses Closed



S	Code	Pack	£.Each
110mm	GS292	1	£43.40
	BS292	1	£43.40
	WS292	1	£43.40

112½° BRANCH

Spigot tail



P	Code	Pack	£.Each
110mm	GS336	1	£50.95
	BS336	1	£50.95

135° BRANCH

Spigot tail



P	Code	Pack	£.Each
82mm	GS614	1	£39.52
110mm	GS278	1	£50.95
	BS278	1	£50.95

92½° CORNER BRANCH

Spigot tail



P	Code	Pack	£.Each
110mm	GS296	1	£207.95
Fabricated.			

DOUBLE BRANCH

Triple Socket



P	Code	Pack	£.Each
110mm	GS295	1	£132.58
	BS295	1	£132.58

92½° CORNER BRANCH

Socket tail



S	Code	Pack	£.Each
110mm	GS301	1	£207.95
Fabricated.			

DOUBLE BRANCH

All Solvent Socket



S	Code	Pack	£.Each
110mm	GS300	1	£132.58
	BS300	1	£132.58

Corner and Double Branches

Designed for commercial installations and houses with multiple bathrooms

Corner branches save space by enabling direct connection of two WCs or WC floats from two directions at 90°

Double branches allow connection of back-to-back WCs and WC floats from opposite directions

GOOD TO KNOW



GOOD TIP

To avoid dislodging or damaging rubber seals, always ensure pipe ends are chamfered and lubricated.

JOBS A GOOD 'UN

SOIL/WASTE FITTINGS GUIDE

- P** Push-fit fittings
- S** Solvent fittings



Each product code is prefixed with a colour.
Example BR125, where 'B' = BLACK



BRACKETS

82/110/160mm
PUSH-FIT &
SOLVENT

BRACKET - PIPE

1 screw
fixing



Code Pack £.Each

110mm	GS217	10	£5.56
	BS217	10	£5.56
	WS217	10	£5.56

BRACKET - PIPE

1 screw
fixing



Code Pack £.Each

160mm	GS412	10	£12.48
	BS412	10	£12.48

BRACKET - PIPE

2 screw
fixing

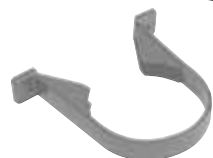

Code Pack £.Each

82mm	GS612	10	£4.89
	BS612	10	£4.89
	WS612	10	£4.89

BRACKET - PIPE

2 screw
fixing



Code Pack £.Each

110mm	GS219	10	£5.80
	BS219	10	£5.80
	WS219	10	£5.80

BRACKET - PIPE/SOCKET

2 screw
fixing



Code Pack £.Each

110mm	GS570	5	£11.26
160mm	GS571	5	£20.28
Galvanised.			

BRACKET - SOCKET

2 screw
fixing



Code Pack £.Each

82mm	GS607	10	£5.71
	BS607	10	£5.71

BRACKET - SOCKET

2 screw
fixing



Code Pack £.Each

110mm	GS220	10	£5.68
	BS220	10	£5.68
	WS220	10	£5.68

GOOD TO KNOW



S612	110mm
S217, S220, S570	90mm
S412, S571	120mm
S219	91mm
S607	75mm

GOOD TIP



Use socket brackets
to support expansion
and contraction



BOSS PIPES

82/110/160mm
PUSH-FIT &
SOLVENT

BOSS PIPE

Socket/Spigot



1 x 50mm
Open Boss
2 x 50mm
Closed Boss

Code Pack £.Each

82mm	GS608	1	£21.03
------	-------	---	--------

4 BOSS PIPE

Socket/Spigot



4 x 50mm
Closed Boss

Code Pack £.Each

110mm	GS244	1	£20.95
	BS244	1	£20.95
	WS244	1	£20.95

32mm BOSS PIPE

Exp. Socket



Code Pack £.Each

110mm	GS216	1	£11.78
	BS216	1	£11.78
	WS216	1	£11.78

Accepts push-fit and solvent waste.

40mm BOSS PIPE

Exp. Socket



Code Pack £.Each

110mm	GS215	1	£11.78
	BS215	1	£11.78
	WS215	1	£11.78

Accepts push-fit and solvent waste.

50mm BOSS PIPE



Code Pack £.Each

110mm	GS218	1	£11.78
	BS218	1	£11.78
	WS218	1	£11.78

For 32/40mm solvent weld use a W717 or W718 waste reducer in the open boss.

90° BOSS ADAPTOR



Code Pack £.Each

32mm	use W104 + W111
40mm	use W106 + W112
50mm	GW275 10 £4.97

For waste manifold.

WASTE MANIFOLD



- Unique square design, ideal for corners
- Integral baffles to prevent cross flow
- Up to four 50mm connections available
- Simple push-fit connections for waste and soil
- Can be adapted to 32mm and 40mm using a GW058 or GW059 boss adaptor.

Code Pack £.Each

110mm	GS200	1	£59.01
-------	-------	---	--------

SOIL/WASTE FITTINGS GUIDE

P Push-fit fittings

S Solvent fittings



Each product code is prefixed with a colour.

Example BR125, where 'B' = BLACK



BOSS ADAPTORS

82/110/160mm PUSH-FIT & SOLVENT

BOSS ADAPTOR – PUSH-FIT ONLY



Compatible with flat snap cap fittings

P	Code	Pack	£.Each
50mm	GS751	10	£7.30

BOSS ADAPTOR – SOLVENT ONLY



Compatible with flat snap cap fittings

S	Code	Pack	£.Each
32mm	GW104	10	£3.91
	BW104	10	£3.91
	WW104	10	£3.91
40mm	GW106	10	£3.91
	BW106	10	£3.91
	WW106	10	£3.91

STRAP BOSS



	Code	Pack	£.Each
82mm	GS610	10	£10.15
110mm	GS343	10	£10.22
	BS343	10	£10.22
	WS343	10	£10.22
160mm	GS437	10	£20.70

50mm Spigot. Bolt not supplied.

CHOOSING THE CORRECT BOSS ADAPTOR.

Compatible with fittings which have a flat snap cap



Compatible with fittings which have a new upstand snap cap



Guide to Boss Connections

- Rubber adaptors suit both Push-fit and Solvent waste pipes.
- For connection of 32, 40 or 50mm.

	32mm	40mm	50mm
Creates Push-fit connection to Push-fit pipework to BSEN1451	Use W058	Use W059	Use S751/S759
Creates Push-fit connection to Solvent pipework to BS5255	Use W058	Use W059	N/A
Creates Solvent connection to Solvent pipework to BS5255	Use W104/W105	Use W106/W107	Use S758

BOSS ADAPTOR – PUSH-FIT ONLY



Compatible with upstand snap cap fittings

P	Code	Pack	£.Each
50mm	GS759	10	£7.30

BOSS ADAPTOR – SOLVENT ONLY



Compatible with upstand snap cap fittings

S	Code	Pack	£.Each
32mm	GW105	10	£3.91
	BW105	10	£3.91
	WW105	10	£3.91
40mm	GW107	10	£3.91
	BW107	10	£3.91
	WW107	10	£3.91
50mm	GS758	10	£4.19
	BS758	10	£4.19
	WS758	10	£4.19

BOSS ADAPTOR

For Push-fit & Solvent Pipe



Compatible with flat and upstand snap cap fittings

P S	Code	Pack	£.Each
	32mm GW058	10	£4.46
	40mm GW059	10	£4.46

Product is black.



REDUCERS

82/110/160mm PUSH-FIT & SOLVENT

82x50mm REDUCER

Spigot tail



S	Code	Pack	£.Each
82mm	GS668	1	£28.86

Accepts 50mm solvent pipe.

REDUCER

Spigot tail



S	Code	Pack	£.Each
110mm	GS264	1	£23.08
	WS264	1	£23.08

50mm to 110mm pipe size.

REDUCER

Spigot tail



S	Code	Pack	£.Each
160mm	GS420	1	£49.24

110x82mm REDUCER

Spigot tail



P	Code	Pack	£.Each
110mm	GS633	1	£28.65
	BS633	1	£28.65

110x82mm REDUCER

Spigot tail



S	Code	Pack	£.Each
110mm	GS636	1	£23.22
	BS636	1	£23.22

FLEXIBLE REDUCER

110mm x 32/40mm



Fits into pipe and fittings.

	Code	Pack	£.Each
110mm	DS025	10	£20.33

Underground terms apply to this item.

FLEXIBLE REDUCER

110mm x 32/40/50mm



	Code	Pack	£.Each
110mm	MKUAG	10	£13.15
	MKUAB	10	£13.15
	MKUAW	10	£13.15

SOCKET PLUG

Spigot tail



	Code	Pack	£.Each
110mm	GS214	1	£14.49
160mm	GS411	1	£32.46

SOIL/WASTE FITTINGS GUIDE

- P** Push-fit fittings
- S** Solvent fittings



Each product code is prefixed with a colour.
Example BR125, where 'B' = BLACK



ACCESS

82/110/160mm PUSH-FIT & SOLVENT

92½° ACCESS BEND

Spigot tail



P	Code	Pack	£.Each
82mm	GS620	1	£39.06
110mm	GS326	1	£72.48
	BS326	1	£72.48

92½° ACCESS BEND

Spigot tail



S	Code	Pack	£.Each
110mm	GS327	1	£66.25
	BS327	1	£66.25

ACCESS SADDLE



Code	Pack	£.Each	
110mm	GS337	10	£22.39

Direct fix to pipework.

ACCESS CAP

Solvent socket



S	Code	Pack	£.Each
110mm	GS667	1	£24.71
	BS667	1	£24.71

ACCESS PLUG

Spigot



Code	Pack	£.Each	
82mm	GS618	1	£21.03
110mm	GS246	1	£24.71
	BS246	1	£24.71
	WS246	1	£24.71

ACCESS PIPE

Double solvent socket



S	Code	Pack	£.Each
110mm	GS310	1	£29.91
	BS310	1	£29.91
	WS310	1	£29.91

ACCESS PIPE

Socket/Spigot



P	Code	Pack	£.Each
82mm	GS616	1	£50.90
	BS616	1	£50.90
110mm	GS309	1	£52.93
	BS309	1	£52.93
160mm	GS472	1	£91.03
	BS472	1	£91.03

92½° ACCESS BRANCH

Spigot tail



P	Code	Pack	£.Each
110mm	GS281	1	£82.12
	BS281	1	£82.12

92½° ACCESS BRANCH

Spigot tail



S	Code	Pack	£.Each
110mm	GS280	1	£72.69
	BS280	1	£72.69



VENTILATION

82/110/160mm PUSH-FIT & SOLVENT

WEATHERING SLATE – FLAT

Accepts 82/110mm soil pipe



Code	Pack	£.Each	
406x406mm	GS590	1	£63.37

WEATHERING SLATE – ANGLED

82/110mm



Code	Pack	£.Each	
457x457mm	GS594	1	£63.37
610x610mm	GS596	1	£107.75

VENT COWL

Code	Pack	£.Each	
82mm	GS634	1	£6.26
	BS634	1	£6.26

VENT COWL

Solvent socket



S	Code	Pack	£.Each
110mm	GS355	1	£7.01
	BS355	1	£7.01
	WS355	1	£7.01
160mm	GS422	1	£17.80

WEATHERING COLLAR

S	Code	Pack	£.Each
82mm	GS635	1	£7.63
	BS635	1	£7.63
110mm	GS358	1	£9.42
	BS358	1	£9.42
	WS358	1	£9.42

EXTRACT COVER

Code	Pack	£.Each	
82mm	RV591	1	£50.39
110mm	RVB592	1	£55.38
	RVW592	1	£55.38
	RV592	1	£55.38

For extract ventilation pipe.

AIR ADMITTANCE VALVE

Solvent socket tail



S	Code	Pack	£.Each
110mm	WS450	1	£62.05

AIR ADMITTANCE INSULATOR



Code	Pack	£.Each	
110mm	WS451	1	£7.46

Polystyrene Insulator for WS450.

SOIL/WASTE FITTINGS GUIDE

- P** Push-fit fittings
- S** Solvent fittings



Each product code is prefixed with a colour.
Example BR125, where 'B' = BLACK



WC CONNECTORS

82/110/160mm
PUSH-FIT &
SOLVENT

From a straight forward job to multiple connections and misaligned pans, there is a Hunter WC Connector for most installations, with all-purpose tails for a speedy connection.



110mm

90° CONNECTOR



Code	Pack	£.Each
WS221	12	£17.98

90° SPACE SAVING CONNECTOR



Code	Pack	£.Each
WS234	12	£28.39

90° CONNECTOR WITH BOSS

32mm Connection



Code	Pack	£.Each
WS228	12	£29.98

STRAIGHT CONNECTOR



Code	Pack	£.Each
WS224	9	£14.62

EXTENSION PIECE



Cut as required opposite end to fins, using a fine tooth saw.

Code	Pack	£.Each
WS226	9	£13.31

GOOD TO KNOW



All 'Tall' Hunter WC Connectors (the ones on this page) can be cut to length!

Simply remove the black finned seal and cut the connector using a fine tooth saw.

JOBS A GOOD'UN™

14° CONNECTOR



Code	Pack	£.Each
WS222	18	£14.62

22mm OFFSET CONNECTOR



Code	Pack	£.Each
WS225	18	£14.62

STRAIGHT CONNECTOR



Code	Pack	£.Each
WS227	27	£14.51

14° CONNECTOR

Spigot tail



To BS5627

Code	Pack	£.Each
WS252	18	£14.99

PIPE - PLAIN ENDED



For exposed pan connection pipework

Code	Pack	£.Each
110mm (1m) WS204	1	£21.65

GASKET



For use with BS1213 pans. Fits 102 - 120mm spigots.

Code	Pack	£.Each
WS248	1	£8.18

GASKET



Fits S252.

Code	Pack	£.Each
WS291	1	£6.39

GOOD TO KNOW



Multikwik®

Larger range of WC connectors in Multikwik range on pg 113



TRUST MULTIKWIK

A BREATH OF FRESH AIR

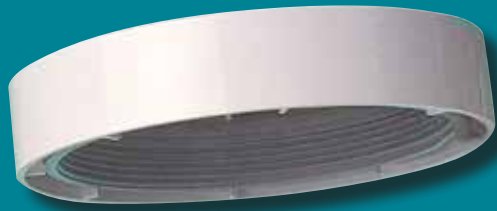

AN AIR ADMITTANCE VALVE YOU CAN SEE WORKING

Unscrew the lid and put a drop of water here

Run downstairs and flush your toilet

Then run back and see if the water is still there!

AIR ADMITTANCE VALVE

Solvent socket tail



S	Code	Pack	£.Each
110mm	WS450	1	£62.05

AIR ADMITTANCE INSULATOR



Code	Pack	£.Each
110mm WS451	1	£7.46

Polystyrene Insulator for WS450.

Prevents the release of foul air
Allows your soil stack to be terminated internally
Provides simple rodding access
Can serve up to five storeys

JOBS A GOOD'UN™

Hunter

FIRE PROTECTION

82/110/160mm
PUSH-FIT &
SOLVENT

Ideal for maintenance and retro-fit.

- Durable stainless steel shell collar
- Secure fixing points
- Interlocking fastening strip to lock collar in position
- Designed for use with 110mm pipework
- Suitable for wall & floor installations
- See Hunter website for more information.

COMPACT FIRE COLLAR



Code	Pack	£.Each
110mm CC110	1	£83.24

Engineered specifically for PCV pipework.

- Intumescent coupling
- Installed using standard solvent jointing methods
- No mechanical fixings required
- Suitable for wall & floor installations.

QUICKSTOP COUPLING

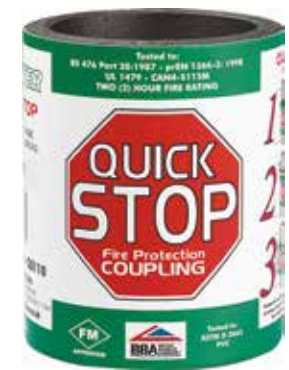

Code	Pack	£.Each
110mm QS110	1	£117.37



FOUNDRY FINISH SOIL

The perfect partner for Foundry Finish Rainwater. A PVC push-fit system with the good looks and charm of Cast Iron.



110mm

PIPE - SOCKETED



Code	Pack	£.Each
CBS508	1	£78.60

2.75 metre

SPIGOT ADAPTOR



Code	Pack	£.Each
CBS121	1	£29.46

Simply push into existing Cast Iron, Clay or PVC pipework.

92½° BEND

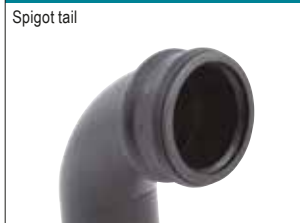

Code	Pack	£.Each
CBS322	1	£47.31

Spigot tail

135° BEND



Code	Pack	£.Each
CBS331	1	£47.31

Spigot tail

92½° BEND



Code	Pack	£.Each
CBS671	1	£49.65

Double socket

135° BEND



Code	Pack	£.Each
CBS676	1	£47.31

Double socket

92½° BRANCH



Code	Pack	£.Each
CBS334	1	£69.95

BOSS PIPE



Code	Pack	£.Each
CBS244	1	£40.22

ACCESS SADDLE



Code	Pack	£.Each
CBS337	1	£30.75

PIPE SUPPORT BRACKET



Code	Pack	£.Each
CBS219	1	£7.79

2 screw fixing

PIPE SOCKET BRACKET



Code	Pack	£.Each
CBS220	1	£7.79

2 screw fixing

FITTING SOCKET BRACKET



Code	Pack	£.Each
CBS572	1	£13.04

2 screw fixing

VENT COWL



Code	Pack	£.Each
CBSV42	1	£9.86

COACH BOLTS FIXINGS

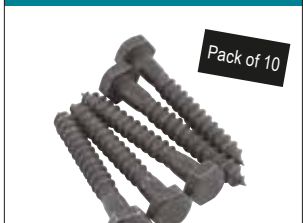

Code	Pack	£.Each
CBF001		£7.88

Pack of 10

GOOD TO KNOW

WE ALSO DO FOUNDRY FINISH RAINWATER SYSTEMS p23-27

B BLACK

Each product code is prefixed with a colour.
Example BR125, where 'B' = BLACK



PUSH-FIT WASTE

POLYPROPYLENE WASTE SYSTEM

Manufactured from double polypropylene material, Hunter Push-fit Waste is resistant to most chemicals and detergents.

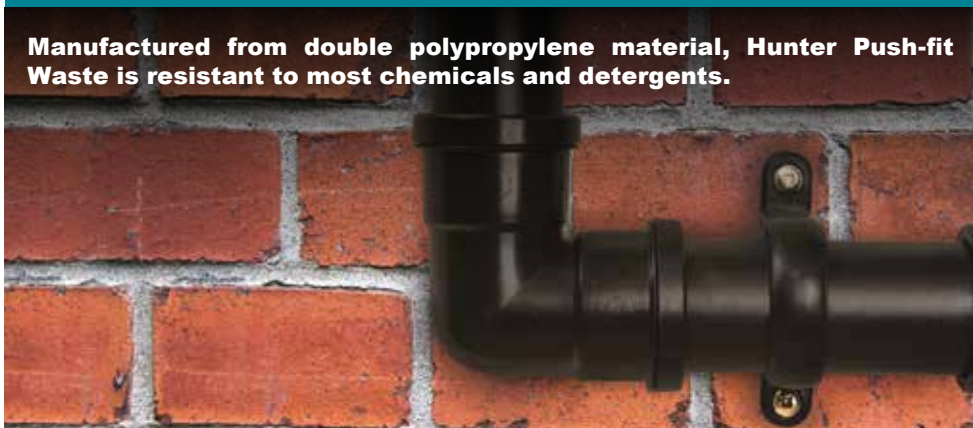

PUSH-FIT WASTE SYSTEM

PIPE - PLAIN ENDED



P	Code	Pack	£.Each
32mm (3m)	GP125	10	£7.55
	BP125	10	£7.55
	WP125	10	£7.55
40mm (3m)	GP150	10	£8.85
	BP150	10	£8.85
	WP150	10	£8.85
50mm (3m)	GP250	10	£15.29

92½° SWEPT BEND



P	Code	Pack	£.Each
32mm	GP010	10	£2.48
	BP010	10	£2.48
	WP010	10	£2.48
40mm	GP020	10	£2.48
	BP020	10	£2.48
	WP020	10	£2.48
50mm	GP200	10	£4.35

135° SWEPT BEND



P	Code	Pack	£.Each
32mm	GP011	10	£2.48
	BP011	10	£2.48
	WP011	10	£2.48
40mm	GP021	10	£2.48
	BP021	10	£2.48
	WP021	10	£2.48
50mm	GP201	10	£4.35

91.5° KNUCKLE BEND



P	Code	Pack	£.Each
32mm	GP017	10	£2.48
	BP017	10	£2.48
	WP017	10	£2.48
40mm	GP027	10	£2.48
	BP027	10	£2.48
	WP027	10	£2.48
50mm	GP207	10	£4.35

135° SPIGOT BEND



P	Code	Pack	£.Each
32mm	GP061	10	£2.48
	BP061	10	£2.48
	WP061	10	£2.48
40mm	GP071	10	£2.48
	BP071	10	£2.48
	WP071	10	£2.48

90° LONG TAIL SPIGOT BEND



P	Code	Pack	£.Each
32mm	GP019	10	£2.48
	BP019	10	£2.48
	WP019	10	£2.48
40mm	GP029	10	£2.48
	BP029	10	£2.48
	WP029	10	£2.48

COUPLING



P	Code	Pack	£.Each
32mm	GP012	10	£2.48
	BP012	10	£2.48
	WP012	10	£2.48
40mm	GP022	10	£2.48
	BP022	10	£2.48
	WP022	10	£2.48
50mm	GP202	10	£4.35

92½° SWEPT TEE



P	Code	Pack	£.Each
32mm	GP013	10	£2.48
	BP013	10	£2.48
	WP013	10	£2.48
40mm	GP023	10	£2.48
	BP023	10	£2.48
	WP023	10	£2.48
50mm	GP203	10	£4.35

SOCKET PLUG



P	Code	Pack	£.Each
32mm	GP014	10	£2.48
	WP014	10	£2.48
40mm	GP024	10	£2.48
	WP024	10	£2.48
50mm	GP204	10	£4.35

REDUCER



P	Code	Pack	£.Each
40x32mm	GP025	10	£2.48
	BP025	10	£2.48
	WP025	10	£2.48
50x32mm	GP208	10	£4.35
50x40mm	GP205	10	£4.35

BRACKET



P S	Code	Pack	£.Each
32mm	GW118	10	£0.99
	BW118	10	£0.99
	WW118	10	£0.99
40mm	GW119	10	£0.99
	BW119	10	£0.99
	WW119	10	£0.99
50mm	GP210	10	£3.13

BOSS ADAPTOR

For Push-fit and Solvent Pipe.



Compatible with upstand and flat snap cap fittings

P S	Code	Pack	£.Each
32mm	GW058	10	£4.46
	GW059	10	£4.46

BOSS ADAPTOR - PUSH-FIT ONLY



Compatible with upstand snap cap fittings. See page 53 for details.

P	Code	Pack	£.Each
50mm	£7.30	10	£7.30
50mm	GS759	10	£7.30

UNIVERSAL TANK CONNECTOR



Accepts Push-fit & Solvent Pipes.

P S	Code	Pack	£.Each
32mm	GW098	10	£4.90
	GW099	10	£4.53
40mm	WW099	10	£4.53

SOIL/WASTE FITTINGS GUIDE

P Push-fit fittings S Solvent fittings

Each product code is prefixed with a colour.
Example BR125, where 'B' = BLACK



SOLVENT WASTE

PVCc/PVC-U WASTE SYSTEM

The system of choice for the pro plumbing installer, once welded the high performance MuPVC provides a permanent watertight connection.



32mm

40mm

50mm

PIPE



S	Code	Pack	£.Each
32mm (3m)	GW538	10	£15.78
	BW538	10	£15.78
	WW538	10	£15.78
32mm (4m)	GW541	10	£20.94
	BW541	10	£20.94
	WW541	10	£20.94
40mm (3m)	GW539	10	£18.98
	BW539	10	£18.98
	WW539	10	£18.98
40mm (4m)	GW542	10	£25.32
	BW542	10	£25.32
	WW542	10	£25.32
50mm (3m)	GW709	10	£27.90
	BW709	10	£27.90
	WW709	10	£27.90
50mm (4m)	GW710	10	£37.16
	BW710	10	£37.16
	WW710	10	£37.16

STRAIGHT COUPLING



S	Code	Pack	£.Each
32mm	GW060	10	£2.88
	BW060	10	£2.88
	WW060	10	£2.88
40mm	GW061	10	£2.88
	BW061	10	£2.88
	WW061	10	£2.88
50mm	GW711	10	£3.75
	BW711	10	£3.75
	WW711	10	£3.75

GOOD TO KNOW



All products are manufactured to BS EN 1566 (or in thick wall PVC-u as applicable). Hunter Solvent Waste should not be used as a high temperature gas boiler exhaust system.

EXPANSION COUPLING



P	S	Code	Pack	£.Each
40mm	GW064	10	£2.88	
	WW064	10	£2.88	

BRACKET



P	S	Code	Pack	£.Each
32mm	GW118	10	£0.99	
	BW118	10	£0.99	
	WW118	10	£0.99	
40mm	GW119	10	£0.99	
	BW119	10	£0.99	
	WW119	10	£0.99	
50mm	GW716	10	£3.03	
	BW716	10	£3.03	
	WW716	10	£3.03	

92½° LONG TAIL SPIGOT BEND



S	Code	Pack	£.Each
32mm	WW113	10	£4.16
	GW113	10	£4.16
	BW113	10	£4.16
40mm	WW114	10	£4.16
	GW114	10	£4.16
	BW114	10	£4.16

OPEN BRACKET



S	Code	Pack	£.Each
50mm	WW122	20	£3.03

92½° SWEPT BEND



S	Code	Pack	£.Each
32mm	GW078	10	£2.88
	BW078	10	£2.88
	WW078	10	£2.88
40mm	GW079	10	£2.88
	BW079	10	£2.88
	WW079	10	£2.88
50mm	GW712	10	£3.75
	BW712	10	£3.75
	WW712	10	£3.75

90° KNUCKLE BEND



S	Code	Pack	£.Each
32mm	GW116	10	£2.88
	BW116	10	£2.88
	WW116	10	£2.88
40mm	GW117	10	£2.88
	BW117	10	£2.88
	WW117	10	£2.88

135° SWEPT BEND



S	Code	Pack	£.Each
32mm	GW082	10	£2.88
	BW082	10	£2.88
	WW082	10	£2.88
40mm	GW081	10	£2.88
	BW081	10	£2.88
	WW081	10	£2.88
50mm	GW713	10	£3.75
	BW713	10	£3.75
	WW713	10	£3.75

135° SPIGOT TAIL BEND



S	Code	Pack	£.Each
32mm	WW108	10	£2.88
40mm	WW109	10	£2.88



SOLVENT WASTE

32/40/50mm WASTE SYSTEM

32mm

40mm

50mm

92½° TEE

Triple socket



S	Code	Pack	£.Each
32mm	GW084	10	£2.88
	BW084	10	£2.88
	WW084	10	£2.88
40mm	GW085	10	£2.88
	BW085	10	£2.88
	WW085	10	£2.88
50mm	GW714	10	£3.75
	BW714	10	£3.75
	WW714	10	£3.75

ACCESS CAP

Spigot tail



S	Code	Pack	£.Each
32mm	GW090	10	£2.88
	BW090	10	£2.88
	WW090	10	£2.88
40mm	GW091	10	£2.88
	BW091	10	£2.88
	WW091	10	£2.88
50mm	GW724	10	£3.75
	BW724	10	£3.75
	WW724	10	£3.75

135° TEE

Triple socket



S	Code	Pack	£.Each
40mm	GW088	10	£2.88
	WW088	10	£2.88
50mm	GW715	10	£3.75
	WW715	10	£3.75

REDUCER

Socket to pipe



S	Code	Pack	£.Each
32x22mm	WW055	10	£2.33
40x32mm	GW057	10	£2.88
	BW057	10	£2.88
	WW057	10	£2.88
50x32mm	GW717	10	£2.88
	BW717	10	£2.88
	WW717	10	£2.88
50x40mm	GW718	10	£2.88
	BW718	10	£2.88
	WW718	10	£2.88



Each product code is prefixed with a colour.
Example BR125, where 'B' = BLACK

91½° CROSS



S	Code	Pack	£.Each
40mm	GW574	10	£12.60
	WW574	10	£12.60
50mm	WW722	10	£12.91

BOSS ADAPTOR – SOLVENT ONLY



S	O	Code	Pack	£.Each
32mm		GW104	10	£3.91
		BW104	10	£3.91
		WW104	10	£3.91
40mm		GW106	10	£3.91
		BW106	10	£3.91
		WW106	10	£3.91

SOIL/WASTE FITTINGS GUIDE

- P** Push-fit fittings
- S** Solvent fittings
- P S** Push-fit AND Solvent fittings
- O** Compatible with fittings which have a flat snap cap
- N** Compatible with fittings which have a new upstand snap cap

CONNECTOR

Male Iron BSPT Adaptor



S	Code	Pack	£.Each
32mm	WW125	10	£2.77
40mm	WW126	10	£2.77
50mm	WW723	10	£5.82

90° BOSS ADAPTOR

For waste manifold (G5200 only)



S	Code	Pack	£.Each
32mm	use W104 + W111		
40mm	use W106 + W112		
50mm	GW725	10	£4.97

BOSS ADAPTOR – PUSH-FIT ONLY



Compatible with flat snap cap fittings

P	Code	Pack	£.Each
50mm	GS751	10	£7.30

UNIVERSAL TANK CONNECTOR



P	S	Code	Pack	£.Each
32mm		GW098	10	£4.90
40mm		GW099	10	£4.53
		WW099	10	£4.53

VENT COWL



S	Code	Pack	£.Each
50mm	GS353	10	£4.23

BOSS ADAPTOR

For Push-fit & Solvent Pipe



Compatible with flat and upstand snap cap fittings

P	S	Code	Pack	£.Each
32mm		GW058	10	£4.46
40mm		GW059	10	£4.46

Product is black.

BOSS ADAPTOR



Compatible with upstand snap cap fittings

S	Code	Pack	£.Each
32mm	GW105	10	£3.91
	BW105	10	£3.91
	WW105	10	£3.91
40mm	GW107	10	£3.91
	BW107	10	£3.91
	WW107	10	£3.91
50mm	GS758	10	£4.19
	BS758	10	£4.19
	WS758	10	£4.19

CUTTER GUIDE

Wondering what size hole cutter you need?

- 48mm for Closed Bosses
- 54mm for the Easy Boss
- 57mm for the Strap-On Boss





OVERFLOW

22mm OVERFLOW SYSTEM

Hunter Overflow has a 22mm full bore discharge for efficient flow removal. Dual purpose fittings offer push-fit or solvent weld assembly.



22mm

PUSH-FIT & SOLVENT OVERFLOW SYSTEM

PIPE – PUSH-FIT ONLY



P	Code	Pack	£.Each
22mm (3m)	WO247	10	£5.04

PIPE – SOLVENT ONLY



S	Code	Pack	£.Each
22mm (3m)	WO232	10	£5.04

UNIVERSAL ADAPTOR



Product is grey.

Connect to other Push fit and Solvent Weld system

P S	Code	Pack	£.Each
22mm	WO220	10	£2.69

STRAIGHT COUPLING



P S	Code	Pack	£.Each
22mm	WO221	10	£2.69

90° BEND



P S	Code	Pack	£.Each
22mm	WO222	10	£2.69

135° BEND



P S	Code	Pack	£.Each
22mm	WO223	10	£2.69

90° TEE



P S	Code	Pack	£.Each
22mm	WO224	10	£2.69

STRAIGHT TANK CONNECTOR



P S	Code	Pack	£.Each
22mm	WO225	10	£2.69

90° TANK CONNECTOR



P S	Code	Pack	£.Each
22mm	WO226	10	£2.69

CLIP

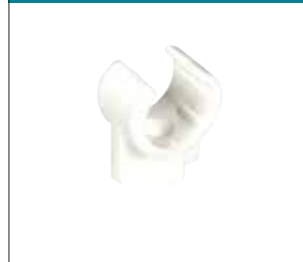

P S	Code	Pack	£.Each
22mm	WO245	10	£0.92

REDUCING BUSH



P	Code	Pack	£.Each
32x22mm	WO233	10	£2.58

REDUCER



S	Code	Pack	£.Each
32x22mm	WW055	10	£2.33

40x22mm CONDENSE ADAPTOR

Multikwik

See Pg 112

- Adapts to condensate line.
- Fits most sizes of overflow.

Code	Pack	£.Each
40mm EB40R	1	£2.80

SOIL/WASTE FITTINGS GUIDE

- P** Push-fit fittings
- S** Solvent fittings

W WHITE

Each product code is prefixed with a colour.
Example BR125, where 'B' = BLACK



ENDURA

Endura is a high quality Grease Management system designed to protect your drains from blocking, by trapping and storing grease.

It is one of the easiest and most cost effective solutions to grease management, allowing you to comply with Part H of the Building Regulations.

moulded. strong. EFFECTIVE



JOBS A GOOD'UN™

ENDURA GREASE INTERCEPTOR



	Code	Pack	£.Each
1.6 l/s	DSG16	1	£635.23
3.2 l/s	DSG32	1	£849.33

ENDURA INLET REDUCER

110x50mm



	Code	Pack	£.Each
	DSG07	1	£27.57

Flexible rubber – will accommodate 56mm diameter pipework.

110mm FLEXIBLE ADAPTOR



	Code	Pack	£.Each
110mm	DS028	1	£42.66

GREASE MANAGEMENT SYSTEM

ENDURA BIO+



4 months supply

Granular Grease Digester – non automated.

	Code	Pack	£.Each
4 x 1kg	DSG11	1	£229.76

ENDURA BIO-G – BIOPAK REFILL



3 months supply

Liquid Grease Digester – BioPak use only.

	Code	Pack	£.Each
12.5l	DSG12	1	£269.95

ENDURA BIOPAK



	Code	Pack	£.Each
	DSG10	1	£697.98

Supplied complete with stainless steel enclosure, 5L Bio-G, programmable dosing pump and all fittings required to install.



PIPE CARRIER

PIPE CARRIER & BRACKET SET



Supplied with mounting brackets.

	Code	Pack	£.Each
3m	GS795	1	£230.38

Carries up to 3m lengths of 82mm pipe

It has reinforced caps to prevent piercing

A hasp & clasp to allow padlocking

And it's supplied with brackets for simple connection

maximise CAPACITY

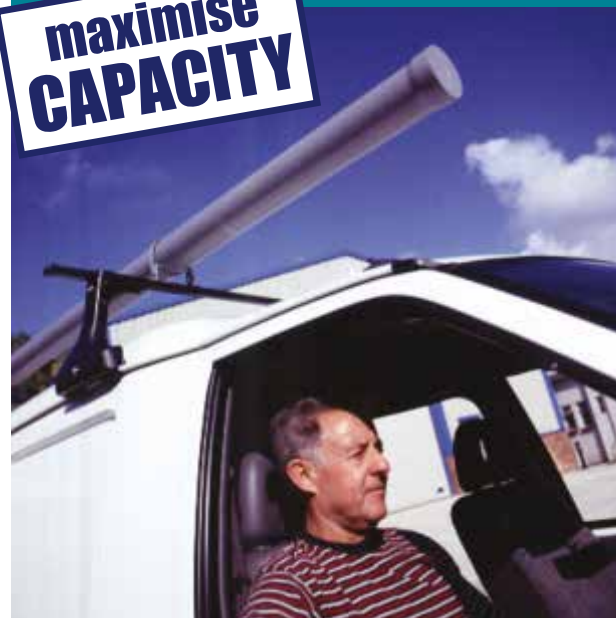



UNDERGROUND

Drain...

Pipes

p75

Couplings

p76

Bends

p77

Junctions

p79

Adaptors & Connectors

p80

Access Fittings

p81

Non-Return Valve

p81

Bottle Gullies

p82

Hoppers

p83

Chambers...

Inspection

p85

Shallow Access

p86

Deep Inspection

p87

Sewers...

Sewer

p89

Structured Wall...

Quantum

p91



110mm/160mm DRAINAGE SYSTEMS

PIPES

A variety of bends, junctions, adaptors, gullies and access fittings designed to help you overcome the most difficult drainage installation and meet the demands of building regulations.



For illustrative purposes only

PIPE



	Code	Pack	£.Each
110mm (3m)	DS505	1	£38.88
110mm (6m)	DS544	1	£77.68
160mm (3m)	DS534	1	£73.87
160mm (6m)	DS545	1	£147.86

Frame Qty: 110mm - 100 | 160mm - 46.

SOCKETED PIPE



	Code	Pack	£.Each
110mm (3m)	DS508	1	£44.24
110mm (6m)	DS549	1	£83.02
160mm (3m)	DS548	1	£92.53
160mm (6m)	DS550	1	£166.47

Frame Qty: 110mm - 100 | 160mm - 46.

SOCKETED LAND DRAINAGE PIPE



	Code	Pack	£.Each
110mm (6m)	DS546	1	£112.12
160mm (6m)	DS547	1	£224.18



110mm/160mm DRAINAGE SYSTEMS

SOCKETS & BENDS

SINGLE SOCKET



	Code	Pack	£.Each
110mm	DS208	1	£17.50
160mm	DS406	1	£33.21

DOUBLE SOCKET



	Code	Pack	£.Each
110mm	DS211	1	£13.34
160mm	DS409	1	£33.21

SLIP COUPLING



	Code	Pack	£.Each
110mm	DS212	1	£26.52
160mm	DS410	1	£43.16

No internal stop.

10° BEND

Spigot tail



	Code	Pack	£.Each
110mm	DS697	1	£21.20

10° BEND

Double socket



	Code	Pack	£.Each
110mm	DS673	1	£25.28

15° BEND

Spigot tail



	Code	Pack	£.Each
160mm	DS408	1	£78.57

20° BEND

Spigot tail



	Code	Pack	£.Each
110mm	DS696	1	£21.20

20° BEND

Double socket



	Code	Pack	£.Each
110mm	DS674	1	£25.28

30° BEND

Spigot tail



	Code	Pack	£.Each
110mm	DS318	1	£28.46
160mm	DS418	1	£75.39



110mm/160mm DRAINAGE SYSTEMS

BENDS



30° BEND
Double socket



	Code	Pack	£.Each
110mm	DS675	1	£25.28

45° BEND
Spigot tail



	Code	Pack	£.Each
110mm	DS331	1	£28.46
160mm	DS404	1	£75.39

45° BEND
Double socket



	Code	Pack	£.Each
110mm	DS676	1	£28.46
160mm	DS432	1	£68.93

87½° 456mm LONG RADIUS BEND



	Code	Pack	£.Each
110mm	DS555	1	£81.11

87½° 686mm LONG RADIUS BEND



	Code	Pack	£.Each
160mm	DS556	1	£190.13

45° 456mm LONG RADIUS BEND



	Code	Pack	£.Each
110mm	DS557	1	£71.42

87½° BEND
Spigot tail



	Code	Pack	£.Each
110mm	DS322	1	£28.46
160mm	DS403	1	£75.39

87½° BEND
Double socket



	Code	Pack	£.Each
110mm	DS671	1	£28.46
160mm	DS431	1	£78.40

ADJUSTABLE BEND
Spigot Tail



Adjusts from 5° - 30°

	Code	Pack	£.Each
110mm	DS329	1	£31.61

45° 686mm LONG RADIUS BEND



	Code	Pack	£.Each
160mm	DS558	1	£163.16

MULTIFLEX BEND
Spigot tail



Adjusts from 0° - 90°

	Code	Pack	£.Each
110mm	MFBSO	1	£31.12

MULTIFLEX BEND
Double socket



Adjusts from 0° - 90°

	Code	Pack	£.Each
110mm	MFBD0	1	£32.31

GOOD TIP

Not sure exactly what angle you need?
Buy an adjustable bend for onsite adjustment

JOBS A GOOD'UN™

87½° REST BEND
Double socket



	Code	Pack	£.Each
110mm	DS663	1	£47.63

PROTECT YOUR STACK!

Always make sure the lowest branch of your soil stack is the right distance away from the invert of your drain.



Height	Min. Vertical	Solution
Up to 3 storeys	450mm	1 x DS663
Up to 5 storeys	740mm	2 x DS676 & a piece of pipe

Pssst... Going even taller than 5 storeys?

Connect the ground floor into their own soil stack or make connections direct to drain. If you get to 20 storeys you'll need to do this for the first floor too!

GOOD TO KNOW





110mm/160mm DRAINAGE SYSTEMS

JUNCTIONS

45° JUNCTION

Double Socket



Code Pack £.Each

110mm	DS278	1	£36.38
160mm	DS430	1	£135.98

45° JUNCTION

Double Socket



Code Pack £.Each

110mm	DS678	1	£47.23
160mm	DS428	1	£148.26

45° UNEQUAL JUNCTION

Double Socket



Code Pack £.Each

160mm	DS471	1	£114.02
160mm x 110mm.			

87½° JUNCTION

Double Socket



Code Pack £.Each

110mm	DS269	1	£36.38
160mm	DS427	1	£135.98

87½° JUNCTION

Triple socket



Code Pack £.Each

110mm	DS672	1	£47.23
-------	-------	---	--------

MULTIFLEX BRANCH

Double socket



Adjusts from 90° - 45°

Code Pack £.Each

110mm	MFYDO	1	£41.67
-------	-------	---	--------

MULTIFLEX BRANCH

Triple socket



Adjusts from 90° - 45°

Code Pack £.Each

110mm	MFYTO	1	£44.17
-------	-------	---	--------

**strong. durable.
RELIABLE**



JOBS A GOOD'UN



110mm/160mm DRAINAGE SYSTEMS

ADAPTORS & CONNECTORS

EAZISLEEVE ADAPTOR

Drain adaptor



Complete with stainless steel clips.

Code Pack £.Each

110mm	DS026	1	£46.60
160mm	DS027	1	£66.70

110mm FLEXIBLE ADAPTOR

PVC - PVC adaptor



Complete with stainless steel clips.
Can be used above ground.

Code Pack £.Each

110mm	DS028	1	£42.66
-------	-------	---	--------

DRAIN CONNECTOR

Finned tail - socket



Code Pack £.Each

110mm	GS121	1	£21.47
	BS121	1	£21.47

SOIL TO DRAIN CONNECTOR

Spigot



Finned Tail for Universal Connection.

Code Pack £.Each

110mm	MKEP110	1	£21.47
-------	---------	---	--------

DRAIN CONNECTOR



PVC-u to Thickwall Clay Pipe.

Code Pack £.Each

110mm	DS350	1	£44.02
-------	-------	---	--------

DRAIN CONNECTOR



PVC-u to Thinwall Clayware Spigot.

Code Pack £.Each

110mm	DS351	1	£41.16
-------	-------	---	--------

DRAIN CONNECTOR



Inspection Chamber to Clay Pipe.

Code Pack £.Each

110mm Thickwall	DS347	1	£23.33
110mm Thinwall	DS348	1	£23.33

DRAIN CONNECTOR



External use only

Code Pack £.Each

	DS024	1	£24.04
Flexible for 50, 65 and 68mm.			

FLEXIBLE REDUCER



Fits into pipe and fittings.

Code Pack £.Each

110mm	DS025	10	£20.33
Accepts 32 or 40mm.			



110mm/160mm
DRAINAGE SYSTEMS

ACCESS & NON RETURN

ACCESS PIPE

Spigot tail



Code Pack £.Each

110mm	DS309	1	£69.57
-------	-------	---	--------

87½° ACCESS BEND

Spigot tail



Code Pack £.Each

110mm	DS326	1	£85.74
-------	-------	---	--------

RODDING POINT

Socket tail



Code Pack £.Each

110mm	DS670	1	£65.14
-------	-------	---	--------

ACCESS CAP

Spigot tail



Code Pack £.Each

110mm	DS246	1	£28.08
160mm	DS421	1	£53.20

SOCKET PLUG



Code Pack £.Each

110mm	DS214	1	£21.08
160mm	DS411	1	£33.99

Also for on-site socket protection.

REDUCER (LEVEL INVERT)



Code Pack £.Each

110 x 82mm	DS633	1	£24.14
160 x 110mm	DS433	1	£33.09

NON RETURN VALVE

Spigot tail



Code Pack £.Each

110mm	DS342	1	£222.84
160mm	DS442	1	£268.77

For surface water only.

A simple & effective device designed to reduce the risk of flood damage caused by surface water flowback.



GOOD TO KNOW

The sturdy integral flap valve helps prevent rodent ingress!

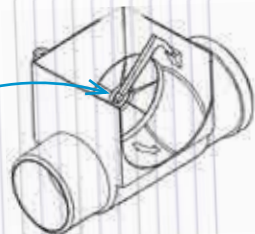

110mm/160mm
DRAINAGE SYSTEMS

GULLIES

GULLY TRAP



Code Pack £.Each

110mm	DS001	1	£65.87
-------	-------	---	--------

Expansion sockets 90° P Trap.

MULTI GULLY TRAP



Code Pack £.Each

110mm	DS012	1	£37.32
-------	-------	---	--------

Use with standard Hunter bends to form P, S and Q Traps.

CIRCULAR TOP BOTTLE GULLY



Includes grid and rodding access. Supplied with removable back inlet plug.

Code Pack £.Each

110mm	DS046	1	£85.07
-------	-------	---	--------

SQUARE TOP BOTTLE GULLY



Includes grid and rodding access. Supplied with removable back inlet plug.

Code Pack £.Each

110mm	DS049	1	£91.35
-------	-------	---	--------

SQUARE GULLY TOP



200mm x 200mm.

Code Pack £.Each

110mm	DS054	1	£24.72
-------	-------	---	--------

For use with DS046.

CIRCULAR GRID GULLY TOP



Code Pack £.Each

110mm	DS055	1	£9.55
-------	-------	---	-------

For use with DS046, DS049 and DS054.

RAISING PIECE



Code Pack £.Each

160mm	DS048	1	£23.91
-------	-------	---	--------

For use with DS046, DS049 and DS054.

SEALED GULLY ACCESS

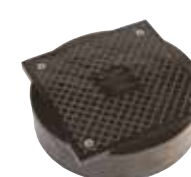

150mm x 150mm

Code Pack £.Each

110mm	DS047	1	£84.56
-------	-------	---	--------

Also fits 110mm and 160mm pipes.



110mm DRAINAGE SYSTEMS

HOPPERS

SQUARE HOPPER

Solvent socket tail



Code Pack £.Each

110mm DS003 1 £15.65

SQUARE HOPPER

230mm spigot tail



Code Pack £.Each

110mm DS002 1 £29.73

SQUARE HOPPER & GRATING

Spigot tail



With grating.

Code Pack £.Each

110mm DS004 1 £35.37

BACK INLET HOPPER

Solvent socket tail



Code Pack £.Each

110mm DS007 1 £20.53

BACK INLET HOPPER

230mm spigot tail



Code Pack £.Each

110mm DS006 1 £47.13

BACK INLET HOPPER & GRATING

Spigot tail



With grating and back inlet plate.

Code Pack £.Each

110mm DS008 1 £56.10

GRATING



Code Pack £.Each

150x150mm DS020 10 £6.46

BACK INLET PLATE

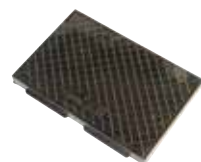

Code Pack £.Each

150x100mm DS011 10 £8.62

SEALED COVER PLATE

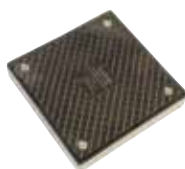

Code Pack £.Each

150x150mm DS022 10 £40.30



110mm/160mm DRAINAGE SYSTEMS

CHANNEL PIPE & FITTINGS

LH 45° CHANNEL BEND



Code Pack £.Each

110mm DS561 1 £46.55

GOOD TIP
Ideas

Adding channel bends into a manhole?
Always face towards the water flow when determining whether right or left hand bends are required.

JOBS A GOOD'UN™

RH 45° CHANNEL BEND



Code Pack £.Each

110mm DS563 1 £46.55

CHANNEL PIPE



Pipe length 1500mm
Opening 635mm

Code Pack £.Each

110mm DS559 1 £81.45

160mm DS560 1 £148.32

Flanges supplied loose.

87½° 455mm LONG RADIUS BEND



Code Pack £.Each

110mm DS566 1 £113.44

SEALED BACK INLET PLATE

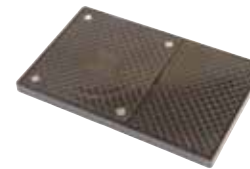

Code Pack £.Each

150x250mm DS010 10 £49.90

DRAIN LEAF GUARD



Pack quantity 15

- Helps to prevent blocked drains
- Fits drains up to 300mm wide x 265mm
- Can accept shapes and types of downpipe
- 32-110mm pipe guides moulded on the inside for easy cutting.

Code Pack £.Each

DS500 15 £17.17



110mm/160mm

INSPECTION CHAMBERS

Hunter inspection chambers are designed to offer an easier, more economical alternative to traditionally constructed manholes.



450mm EQUAL CHAMBERBASE



263mm invert

110mm connections

Code Pack £.Each

450mm	DS050	1	£145.72
-------	-------	---	---------

3 sockets supplied with blanking plugs.

450mm UNEQUAL CHAMBERBASE



360mm invert

110mm & 160mm connections

Code Pack £.Each

450mm	DS066	1	£218.33
-------	-------	---	---------

Side sockets supplied with blanking plugs.

BLANKING PLUG



Code Pack £.Each

110mm	DS056	1	£6.54
-------	-------	---	-------

SQUARE/ROUND ACCESS COVER

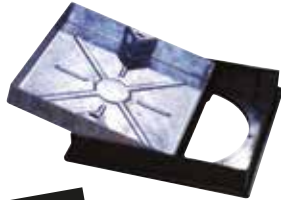

5 tonne loading

Code Pack £.Each

565x565mm	DS065	1	£183.57
-----------	-------	---	---------

Suits pedestrian areas/domestic driveways (accepts paviors).

SQUARE COVER AND FRAME

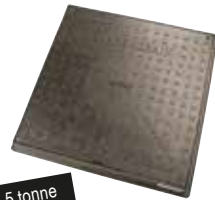

3.5 tonne loading

Code Pack £.Each

580x580mm	DS076	1	£140.68
-----------	-------	---	---------

Durable polypropylene, suits pedestrian areas/domestic driveways. Lockable cover complies with Building Regs Part H.

RAISING PIECE



164mm effective height

Code Pack £.Each

450mm	DS058	1	£56.96
-------	-------	---	--------

For use with DS050 or DS066.

ROUND COVER AND FRAME



3.5 tonne loading

Code Pack £.Each

450mm	DS062	1	£98.91
-------	-------	---	--------

Durable polypropylene, suits pedestrian areas/domestic driveways. Lockable cover complies with Building Regs Part H.

CHAMBERBASE SEAL



Code Pack £.Each

450mm	DS067	1	£42.99
-------	-------	---	--------

For DS066 base to first riser only.



110mm

SHALLOW ACCESS

230mm EQUAL CHAMBERBASE



140mm invert

110mm connections

Code Pack £.Each

230mm	DS071	1	£81.12
-------	-------	---	--------

Side sockets supplied with blanking plugs.

RAISING PIECE



205mm effective height

Code Pack £.Each

250mm (OD)	DS072	1	£39.43
------------	-------	---	--------

2 risers form 600mm overall height.

SQUARE/ROUND ACCESS COVER



3.5 tonne loading

Code Pack £.Each

390x390x70mm	DS075	1	£159.89
--------------	-------	---	---------

Suits pedestrian areas/domestic driveways (accepts paviors).

ALUMINIUM COVER AND FRAME



Code Pack £.Each

265mm	DS039	1	£84.13
-------	-------	---	--------

Suits pedestrian areas only. 1 tonne loading.

O RING SEAL

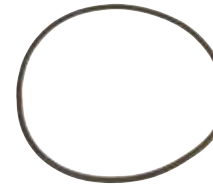

To form sealed access

Code Pack £.Each

250mm	DS040	1	£11.12
-------	-------	---	--------

For DS039 only.

ROUND PVC-U COVER



Sealed unit

Code Pack £.Each

275mm	DS069	1	£89.20
-------	-------	---	--------

Suits pedestrian areas only. 1 tonne loading.

SQUARE PVC-U COVER



Code Pack £.Each

320x258mm	DS068	1	£113.28
-----------	-------	---	---------

Suits pedestrian areas only. 1 tonne loading.

GOOD TO KNOW

ASSEMBLY HEIGHT GUIDE

Max depth 1200mm (for DS050, DS066)
Max depth 600mm (for DS071)

	DS050	DS066	DS071
Base only	280mm	360mm	189mm
Base with 1 riser	444mm	524mm	394mm
Base with 2 risers	608mm	688mm	600mm
Base with 3 risers	772mm	852mm	-
Base with 4 risers	936mm	1016mm	-
Base with 5 risers	1100mm	1180mm	-



110mm/160mm

DEEP INSPECTION

CHAMBER BASE

All socket connections



Code Pack £.Each

450mm UCC3D 1 £714.56

Max invert depth 4m (when used with UCR3 Riser).

450mm UNEQUAL CHAMBERBASE



360mm invert

110mm & 160mm connections

Code Pack £.Each

450mm DS066 1 £218.33

Side sockets supplied with blanking plugs. Use with a SR450 and UCR3.

CHAMBER RISER CLIP



Pack quantity 10

Code Pack £.Each

UCC10D 10 £20.37

For use with UCR3 Riser.

CHAMBER RISER



Code Pack £.Each

450mm UCR3 1 £132.80

For use with UCC3D. Max invert depth 4m.

SQUARE COVER AND FRAME

Polypropylene with reduced access ring.

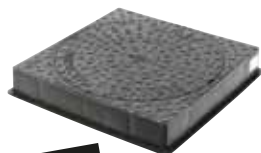

3.5 tonne loading

Code Pack £.Each

450mm UCL35SQR 1 £164.31

Suits pedestrian areas / domestic driveways.

CIRCULAR COVER AND FRAME



3.5 tonne loading

Code Pack £.Each

450mm UCL35PP 1 £123.17

Suits pedestrian areas / domestic driveways.

REDUCED ACCESS RING



Code Pack £.Each

450mm UCLRR 1 £92.15

Provides 350mm restriction opening. Use with UCL35PP and UCL35SQR.

SPARE RING SEAL

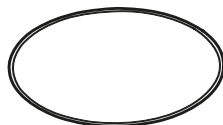

Code Pack £.Each

450mm SR450 1 £10.29

BLANKING PLUG



Code Pack £.Each

110mm DS056 1 £6.54



Sewer systems

STRONG. DURABLE. RELIABLE.

JOBS A GOOD'UN™



200mm/250mm/315mm DRAINAGE SYSTEMS

SEWER

Light in weight and easy to install. The Hunter Sewer System has a high performance integral sealing system that ensures your joints remain leak free for years to come.



200mm

250mm

315mm

PIPE

Plain ended

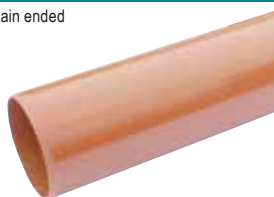

Code	Pack	£.Each
200mm (6m)	DS744	1 £302.45
315mm (6m)	DS771	1 £854.72

SINGLE SOCKET

Solvent socket tail



Code	Pack	£.Each
200mm	DS729	1 £69.60

DOUBLE SOCKET

Socket tail



Code	Pack	£.Each
200mm	DS730	1 £69.60
250mm	DS753	1 £131.07
315mm	DS773	1 £209.81

SOCKETED PIPE



Code	Pack	£.Each
250mm (6m)	DS752	1 £547.68

87½° BEND

Spigot tail



Code	Pack	£.Each
200mm	DS731	1 £107.07
250mm	DS754	1 £356.84
315mm	DS774	1 £535.34

45° BEND

Spigot tail



Code	Pack	£.Each
200mm	DS732	1 £89.22
250mm	DS755	1 £249.82

30° BEND

Spigot tail



Code	Pack	£.Each
200mm	DS733	1 £85.70

15° BEND

Spigot tail



Code	Pack	£.Each
200mm	DS728	1 £84.14

45° JUNCTION

Spigot tail



Code	Pack	£.Each
200mm	DS734	1 £148.74
250mm	DS758	1 £475.83

160mm 45° UNEQUAL JUNCTION

Spigot tail



Code	Pack	£.Each
200mm	DS735	1 £124.90
250mm	DS760	1 £321.17

200mm 45° UNEQUAL JUNCTION

Spigot tail



Code	Pack	£.Each
315mm	DS781	1 £678.06

ACCESS PIPE

Spigot tail



Code	Pack	£.Each
200mm	DS739	1 £135.57

REDUCER



Code	Pack	£.Each
200x160mm	DS738	1 £50.56
250x160mm	DS762	1 £78.43
250x200mm	DS763	1 £130.83

SOCKET PLUG



Code	Pack	£.Each
200mm	DS737	1 £41.63

Also for on-site socket protection.

GOOD TIP



For full information on bedding and backfilling procedures, please refer to our website: www.hunterplastics.co.uk

JOBS A GOOD'UN™



150mm/225mm/300mm DRAINAGE SYSTEMS

QUANTUM

Quantum is a twin wall, structured drainage system designed to tolerate ground movement. Available in 3 sizes with a range of **GOOD** dual purpose fittings designed for use with Quantum Highway or Sewer Pipes.

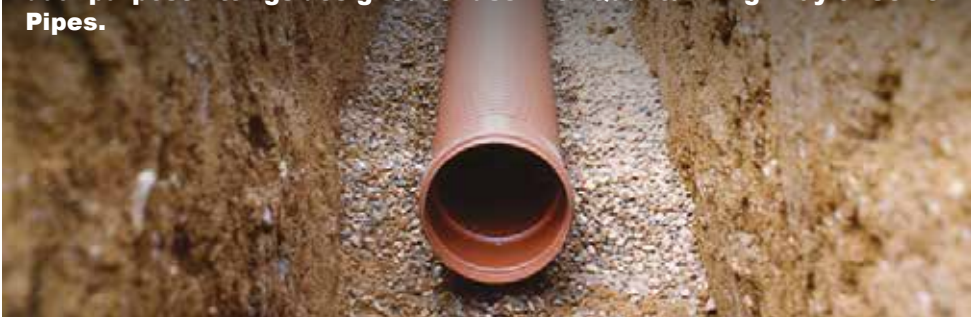

WHEN ORDERING PLEASE NOTE:

- = Seals supplied
- = Seals to be ordered

150mm

225mm

300mm

SOCKETED HIGHWAY PIPE



Code	Pack	£.Each
150mm (6m) UPH16	1	£42.23
225mm (6m) UPH26	1	£105.65
300mm (6m) UPH36	1	£165.97

SOCKETED HIGHWAY PIPE



Code	Pack	£.Each
150mm (6m) UHH16	1	£44.62
225mm (6m) UHH26	1	£111.20
300mm (6m) UHH36	1	£173.07

SOCKETED HIGHWAY PIPE



Code	Pack	£.Each
150mm (6m) USH16	1	£44.62
225mm (6m) USH26	1	£111.20
300mm (6m) USH36	1	£173.07

SEWER PIPE

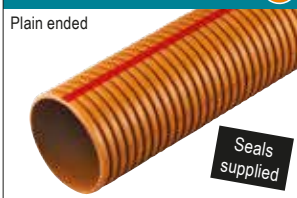

Code	Pack	£.Each
150mm (3m) ULS13	1	£28.44
150mm (6m) ULS16	1	£56.85
225mm (3m) ULS23	1	£81.17
300mm (3m) ULS33	1	£119.36

SOCKETED SEWER PIPE

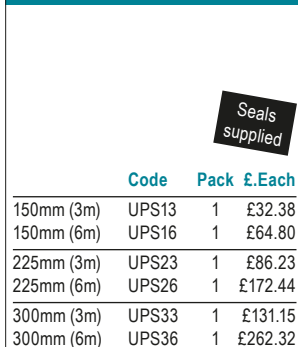

Code	Pack	£.Each
150mm (3m) UPS13	1	£32.38
150mm (6m) UPS16	1	£64.80
225mm (3m) UPS23	1	£86.23
225mm (6m) UPS26	1	£172.44
300mm (3m) UPS33	1	£131.15
300mm (6m) UPS36	1	£262.32

COUPLING



Code	Pack	£.Each
150mm UME15Q	4	£17.32
225mm UME25	2	£42.24
300mm UME35	1	£82.06

SLIP COUPLING



Code	Pack	£.Each
150mm UME16Q	4	£17.32
225mm UME26	2	£42.24
300mm UME36	1	£82.06

LEVEL INVERT REDUCER



Code	Pack	£.Each
225x150mm UML21	1	£95.43
300x225mm UML32	4	£207.21

UML21 – Remove seal from 150mm socket to accept Quantum pipe.

FLEXIBLE COUPLING



Code	Pack	£.Each
150mm UMD17	25	£97.13
225mm UMD27	13	£120.48

END CAP



Code	Pack	£.Each
150mm UMK11	52	£11.41
225mm UMK21	1	£67.23
300mm UMK31	1	£160.41

Push-fits over Quantum pipe with the seal in the first corrugation of the pipe.

SOCKET PLUG



Code	Pack	£.Each
150mm UMJ11	54	£23.48

Push-fits into socket with Quantum seal fitted into the first corrugation.

RODDING POINT TERMINAL



Code	Pack	£.Each
150mm URP2Q	1	£113.73

Tested to 35kN test loads, suitable for driveway applications when supported with concrete surround.

ADAPTOR TO CLAYWARE



Code	Pack	£.Each
150mm UMA45	1	£48.32

Remove seal from socket to accept Quantum pipe.

ADAPTOR



Code	Pack	£.Each
160x150mm UMA17	1	£30.02

QUANTUM

150mm

225mm

300mm

87½° BEND

Double socket



Code Pack £.Each

150mm	UMB19Q	2	£34.84
-------	--------	---	--------

90° BEND

Double socket



Code Pack £.Each

225mm	UMB29	1	£167.39
300mm	UMB39	1	£300.06

45° BEND

Double socket



Code Pack £.Each

150mm	UMB14Q	2	£30.26
225mm	UMB24	1	£120.09
300mm	UMB34	1	£223.29

225mm 45° UNEQUAL BRANCH

Triple socket



Code Pack £.Each

300mm	UMY32	1	£493.94
-------	-------	---	---------

110mm 87½° UNEQUAL BRANCH

Triple socket



Code Pack £.Each

150mm	UMY12Q	2	£53.13
-------	--------	---	--------

110mm sockets accept solid wall pipe.

SNAP CAP AND SEAL

Seals in packs of 5



Code Pack £.Each

Seal	SR160T		£6.24
Snap Cap	SNC6	10	£4.33

To convert 150mm Quantum fittings to accept 160mm solid wall pipe.

30° BEND

Double socket



Code Pack £.Each

150mm	UMB13Q	2	£30.26
225mm	UMB23	1	£120.09
300mm	UMB33	1	£223.29

15° BEND

Double socket



Code Pack £.Each

150mm	UMB11Q	2	£30.26
225mm	UMB21	1	£120.09
300mm	UMB31	1	£223.29

87½° EQUAL BRANCH

Triple socket



Code Pack £.Each

150mm	UMY13Q	2	£60.50
-------	--------	---	--------

GULLY POT LINER



Supplied with SNC6 snap cap and SR61T seal for use with Quantum bend or coupling to provide connection to gully spigot.

British board of Agrément Approved Roads & Bridges Certificate No 91/RO66 and complies with Department of Transport 'Specification for Highway Works'.

Code Pack £.Each

90 Litres	UMA43	1	£95.63
112 Litres	UMA49	1	£117.25

SPARE QUANTUM PIPE SEALS

Seals in packs of 5



Conforms to BS EN 681-1 1996 Type WC

Code Pack £.Each

150mm	UMR150		£1.87
225mm	UMR225		£3.74
300mm	UMR300		£9.10

45° EQUAL BRANCH

Triple socket



Code Pack £.Each

150mm	UMY11Q	2	£60.50
225mm	UMY22	1	£282.04
300mm	UMY33	1	£652.28

110mm 45° UNEQUAL BRANCH

Triple socket



Code Pack £.Each

150mm	UMY10Q	2	£53.13
225mm	UMY20	1	£172.24
300mm	UMY30	1	£272.05

110mm sockets accept solid wall pipe.

150mm 45° UNEQUAL BRANCH

Triple socket



Code Pack £.Each

225mm	UMY21	1	£143.35
300mm	UMY31	1	£233.16

UMY21 150mm socket – Add snap cap & seal to accept Quantum pipe.
UMY31 150mm socket – Remove seal to accept Quantum pipe.



Quantum sewer pipes have a red strip painted along each length to help distinguish them from Quantum highway pipes.



LUBRICANT



Code Pack £.Each

250ml	SC966	1	£17.80
-------	-------	---	--------



SPECIAL FABRICATIONS

Fabrication Service

Hunter realises that not all product requirements can be achieved through standard components.



Rainwater Guttering

Any degree angle through 1 plane
£.Each

Half Round 112mm

BRF100 – Black	£34.79
GRF100 – Grey	£34.79
VRF100 – Vandyke Brown	£34.79
WRF100 – White	£34.79

Half Round 76mm

BRF800 – Black	£36.56
GRF800 – Grey	£36.56
VRF800 – Vandyke Brown	£36.56
WRF800 – White	£36.56

Half Round 125mm to 112mm gutter adaptor

BRF901 – Black – L/H	£26.38
GRF901 – Grey – L/H	£26.38
VRF901 – Vandyke Brown – L/H	£26.38
WRF901 – White – L/H	£26.38
BRF902 – Black – R/H	£26.38
GRF902 – Grey – R/H	£26.38
VRF902 – Vandyke Brown – R/H	£26.38
WRF902 – White – R/H	£26.38

Squareflo 114mm

BRF200 – Black	£34.79
VFR200 – Vandyke Brown	£34.79
WRF200 – White	£34.79

125

BRF300 – Black	£36.84
VRF300 – Vandyke Brown	£36.84
WRF300 – White	£36.84

Regency 125mm

BRF400 – Black	£44.16
VRF400 – Vandyke Brown	£44.16
WRF400	£42.46

Highflo 170mm

BRF600 – Black	£48.43
GRF600 – Grey	£48.43
WRF600 – White	£48.43

Stormflo 200mm

BRF700 – Black	£177.33
GRF700 – Grey	£177.33

Vent Cover

RV593 160mm – Grey	£62.63
RVB593 160mm – Black	£62.63
RVW593 160mm – White	£62.63



INSTALLATION

STEP ONE



Before starting work, identify position of drain, run a plumb-line and fix gutter outlet. Check fascia is level and determine fall (if required).

STEP TWO



Fix support bracket at furthest end and run a string-line to the outlet.

STEP THREE



From outlet, fix support brackets at a maximum of one metre centres.

STEP FOUR



Insert gutter to the 'insert to here' line on the first fitting. At the other end of the gutter mark the position of the next fitting on the fascia.

STEP FIVE



Remove gutter and fix next fitting using your mark line. Ensuring fittings are level by using a string line.

STEP SIX



Fit length of gutter and stop end, with support bracket at furthest end.

STEP SEVEN



Fit top offset bend to outlet, then using bottom offset determine length of pipe required.

STEP EIGHT



Fit a pipe clip below the bottom offset, then at a maximum of two metres apart.

STEP NINE



Check water tightness by blocking off any outlet and performing a static water test.



Tip for Surefit Clips: Insert the rear gutter edge under the back retaining lip of the snap lock clip. Ensure that it is fully home. With all fingers over the front edge of the gutter, pull down, while pushing up on the fitting with your thumbs until the gutter snaps into position. **DO NOT REMOVE THE SUREFIT CLIPS.**

RAINWATER CALCULATIONS

On face value, guttering installation is a piece of cake, but it is amazing how many installers get it wrong.



It's simple with Hunter Surefit!

An easy to use rainwater calculator can be found on our website www.hunterplastics.co.uk

Step Two: Select Your CONFIGURATION and Profile

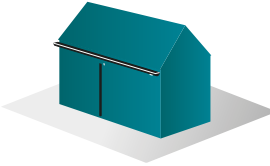
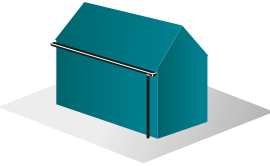
Flow Capacity:		Gutter Fixed Level		Gutter Fixed at 1:350	
		Gutter Flow (Litres/Sec)	Roof Area m ²	Gutter Flow (Litres/Sec)	Roof Area m ²
Downpipe at centre 	HALF ROUND				
	76mm	0.7	34	0.8	38
	112mm	1.8	86	2.6	125
	SQUAREFLO	3.2	154	3.8	182
	125				
	68mm (Downpipe)	3.8	182	4.6	221
	82mm (Downpipe)	4.0	191	4.9	235
	REGENCY	4.2	202	4.7	226
	HIGHFLO	5.4	258	6.0	289
	STORMFLO				
	110mm	11.1	534	12.4	598
	160mm	12.5	601	14.0	673
Downpipe at end 	HALF ROUND				
	76mm	0.5	24	0.6	29
	112mm	0.9	43	1.3	62
	SQUAREFLO	1.6	77	2.0	96
	125				
	68mm (Downpipe)	2.1	101	2.4	115
	82mm (Downpipe)	2.2	106	2.5	120
	REGENCY	2.1	101	2.3	110
	HIGHFLO	2.8	136	2.9	137
	STORMFLO				
	110mm	5.9	282	5.9	284
	160mm	6.6	318	6.7	320

Compatibility Table

	Rainwater			Waste	Soil		Underground	
	Half Round	Squareflo	125	110mm	Push-fit	Solvent	110mm	160mm
Hepworth	✓	✓	✓	✓	✓	✓	✓	✓
Marley	✓	✗	✓	✓	✓	✓	✓	✓
Osma	✓	✗	✓	✓	✓	✓	✓	✓
Polypipe	✓	✓	✓	✓	✓	✓	✓	✓
Brett	✓	✗	✓	✓	✓	✓	✓	✓

Hunter products are compatible with many other manufacturers' systems and with traditional cast iron and aluminium systems.

Step One: Calculate Effective Maximum Roof Area

This can be calculated by using the following formula (see diagram below):

$$B + \frac{C}{2} \times \text{length of roof} = \text{area in m}^2$$

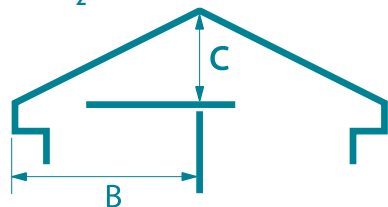

Calculating effective roof areas where gutter angles are installed

Effect of angles – If a length of eaves gutter includes an angle, the flow in the gutter will be impeded and its capacity reduced by 15%. Where an angle occurs in a length of gutter served by two outlets, the reduction factor of 0.85 should only be applied to that part of the gutter in which the angle obstructs the flow. These figures are based on a rainfall intensity of 75mm/hr, roof pitch not exceeding 50°, gutters running full.

Refer to BSEN 12056, Part 3: Roof drainage, layout and calculations.

GOOD TIP



TIP

Installation Tips

- For gutter fixings onto wooden fascias use 25mm x No.10 round head rust proof screws
- For gutter fixings onto PVC fascias use 35mm x 5mm No.10 parallel thread zinc plated or stainless steel, recess pan head, single-start self tapping screws
- For downpipe supports use 32mm x No.10 screws to masonry wall plugs

Traps...

Bottle



p101

Running & Shower



p103

Bath & Utility



p105

Waste...

Ventilation & Accessories



p105

Waste & Overflow



p109

Compression Waste



p110

WC Connectors...

Straight



p113

Offsets



p115

Bends



p117

Sanitary Systems...

Cisterns & Valves



p121



Proteus



p123

Hidden Frames



p124

Ancillaries...

Flush Plates & Buttons



p125

Toilet Seats



p127

Floor Drainage



p128

Multikwik traps are designed to offer a secure watertight joint and can help you achieve a **GOOD** 'fuss free' installation.

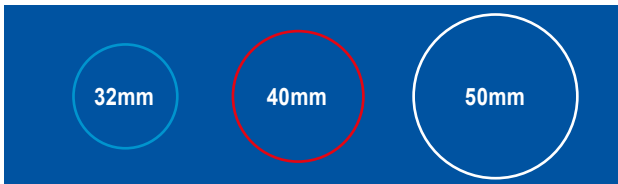

BOTTLE - SLIMLINE



Space saving for vanity unit.

	Code	Pack	Box	£.Each
32mm	BS032	5	40	£5.97

STRAIGHT THROUGH TRAP



- Slimline design.
- Adjustable telescopic outlet.
- Easy assembly and disassembly for maintenance after installation.
- Designed to reduce flow variations and help retain water seal.
- Offers similar performance to Anti Vac traps.

	Code	Pack	Box	£.Each
32mm	ST032	10	40	£7.18

BOTTLE - STANDARD



	Code	Pack	Box	£.Each
32mm	B032	10	50	£5.71
40mm	B040	10	40	£6.50

BOTTLE - RESEALING



	Code	Pack	Box	£.Each
32mm	B032R	10	50	£7.48
40mm	B040R	10	40	£8.79

BOTTLE - ADJUSTABLE



	Code	Pack	Box	£.Each
32mm	B032A	10	40	£6.93
40mm	B040A	10	40	£8.31

BOTTLE - ADJUSTABLE/RESEAL



	Code	Pack	Box	£.Each
32mm	B032RACR	1	40	£23.91
40mm	B040RACR	1	40	£24.99

BOTTLE - ADJUSTABLE



Includes 400 x 32mm chromed waste pipe

	Code	Pack	Box	£.Each
32mm	B032ACR	1	20	£26.67

UNIVERSAL ALL-IN-ONE



Outlet adjusts 360°

	Code	Pack	Box	£.Each
32mm	SP032	10	50	£7.46
40mm	SP040	10	40	£8.34

BOTTLE - ADJUSTABLE/RESEAL



	Code	Pack	Box	£.Each
32mm	B032RA	5	40	£8.72
40mm	B040RA	5	30	£10.07

BOTTLE - ANTI VAC



	Code	Pack	Box	£.Each
32mm	B032V	10	50	£7.60
40mm	B040V	10	50	£8.98

BOTTLE - COMPACT



	Code	Pack	Box	£.Each
32	B032S	5	65	£4.79
40mm	B040S	5	50	£5.51

GOOD TO KNOW



Water seal

BS EN 12056-2:2000 states that traps which discharge to a soil stack should have a 75mm seal.

This is not always possible directly at the outlet due to size restrictions, so other seal depths can be installed...

- **50mm water seal** can be fitted to baths, shower trays & basins without plugs and having spray taps.
- **38mm water seal** can be used on ground floors when connecting to flat bottomed appliances that discharge to a back inlet gully.

All our traps have 75mm Seals unless otherwise stated.

32mm

40mm

50mm

TUBULAR SWIVEL TRAP



- Both inlet and outlet swivel to allow an easy connection, even in confined areas.
- Telescopic inlet for maximum adjustment.

	Code	Pack	Box	£.Each
40mm	SWM040A	5	40	£11.65

Use NKT001 nozzle for appliance connection.

P TRAP



	Code	Pack	Box	£.Each
32mm	P032	10	60	£4.97
40mm	P040	10	40	£5.89
50mm	P050	5	50	£10.81

COMPACT SHOWER TRAP



	Code	Pack	Box	£.Each
70mm Flange				
C 50				
40mm	S5040C	10	40	£15.51

COMPACT SHOWER TRAP



	Code	Pack	Box	£.Each
70mm Flange				
W 50				
40mm	S5040W	10	40	£15.02

GOOD TO KNOW

Install a resealing shower trap to eliminate self-siphonage and eradicate the gurgling in your system.



RUNNING S TRAP



	Code	Pack	Box	£.Each
32mm	S032	10	60	£5.99
40mm	S040	10	40	£6.97

RUNNING



	Code	Pack	Box	£.Each
32mm	RP032	5	50	£7.45
40mm	RP040	5	35	£7.91
50mm	RP050X	5	40	£15.28

ADJUSTABLE TRAP



	Code	Pack	Box	£.Each
32mm	P032A	10	50	£6.24
40mm	P040A	10	40	£7.17

RESEALING SHOWER TRAP



	Code	Pack	Box	£.Each
70mm Flange				
C 50				
40mm	S5040CR	5	40	£15.78

GOOD TO KNOW

To save time on site all Multikwik traps have unique slip ring colours to aid size identification

32mm – Suitable for hand basins, bidets, bar wells and drinking fountains

40mm – Suitable for baths, showers, sinks, urinals and kitchen appliances

50mm – Suitable for a range of basins, urinals, catering sinks and hospital appliances.

GOOD TO KNOW

All 40mm shower traps are supplied with an access key for installation, easy cleaning and maintenance



COLOUR

- W White
- C Chrome
- G Gold

WATER SEAL

- 99 Water seal size
- Note: All our traps have 75mm Water Seals unless otherwise stated.

32mm

40mm

50mm

LOW LEVEL BATH TRAP



19	Code	Pack	Box	£.Each
40mm	P1940	10	80	£4.60

LOW LEVEL BATH TRAP



50	Code	Pack	Box	£.Each
40mm	P5040	10	40	£5.87

LOW LEVEL BATH TRAP



50	Code	Pack	Box	£.Each
40mm	P5040F	1	20	£14.38

WASHING MACHINE TRAP



Code	Pack	Box	£.Each
40mm PWM040	5	30	£8.92

P SINGLE UTILITY COMPACT TEE



Code	Pack	Box	£.Each
40mm PWM040T	10	60	£10.84

P SINGLE UTILITY NOZZLE



Adjustable			
Code	Pack	Box	£.Each
40mm PWM040S	10	30	£9.82

LOW LEVEL SWIVEL P BATH TRAP



Code	Pack	Box	£.Each
40mm P040L	5	40	£6.82

STANDARD BATH TRAP



60	Code	Pack	Box	£.Each
40mm	P6040	5	35	£5.87

STANDARD BATH TRAP



60	Code	Pack	Box	£.Each
40mm	P6040F	5	40	£14.38

P DOUBLE UTILITY NOZZLE



Adjustable			
Code	Pack	Box	£.Each
40mm PWM040D	10	40	£10.39

S SINGLE UTILITY NOZZLE



Adjustable			
Code	Pack	Box	£.Each
40mm SWM040S	10	30	£11.09

S DOUBLE UTILITY NOZZLE



Adjustable			
Code	Pack	Box	£.Each
40mm SWM040D	5	25	£12.42

LOW LEVEL ANTI VAC BATH TRAP



50	Code	Pack	Box	£.Each
40mm	P5040V	5	80	£8.37

GURGLE MASTER



- Converts any trap into an anti-vac trap
- Allows air into the waste pipes to prevent the gurgling of the water seal.
- Simple multifit inline assembly for quick installation.

Code	Pack	Box	£.Each
32mm WV032	10	150	£4.39
40mm WV040	10	100	£4.39

ANTI SIPHON UNIT



BBA BRITISH BOARD OF AGREEMENT COMMERCIAL MEMBER			
Code	Pack	Box	£.Each
32mm WW150	10	100	£6.08
40mm WW151	10	100	£6.50

Use with any BS 5255 / BS EN 1566 solvent weld socket

GOOD TO KNOW



Part H of Building Regs requires ventilation of a soil stack to prevent water seals being drawn.

Multikwik offers a number of unique and innovative solutions for ventilation of drainage systems.

Plus there's an Air Admittance Valve in the Hunter range p56



32mm

40mm

50mm

SPACE SAVER



- Pushes the trap and pipework to the back of the cupboard.
- Maximise under-sink storage space.
- Trap supplied separately
- 50mm seal depth

	Code	Pack	Box	£.Each
40mm	SBSK040	5	30	£7.00

SPACE SAVER KIT



Single bowl – double nozzle

	Code	Pack	Box	£.Each
40mm	SBK040D	1	25	£13.53

NOZZLE



Spigot suits 1" and 3/4" hose connection.
Blanking cap provided – must be removed when connecting appliance.
Non return valve to prevent backflow

	Code	Pack	Box	£.Each
40mm	NK001	10	300	£1.94

STRAIGHT NOZZLE



	Code	Pack	Box	£.Each
40mm	NKT001	10	180	£1.33

Use with 40mm compression waste appliance hose connection.

GOOD TO KNOW

Multikwik Nozzles allow a simple connection for washing machines and dishwashers.

The spigot can be cut back to provide a 3/4" BSPT male thread.

And they're supplied with a blanking cap and non return valve to prevent the backflow of water.



Remember to remove the blanking plug when you connect your appliance!

1½ BOWL KIT



1½ bowl – single nozzle

	Code	Pack	Box	£.Each
40mm	XSB040S	1	35	£13.50

DOUBLE BOWL KIT



Double bowl – single nozzle

	Code	Pack	Box	£.Each
40mm	DBK040S	1	30	£15.39

EXTENDED DOUBLE BOWL KIT



Double bowl – double nozzle

	Code	Pack	Box	£.Each
40mm	DBKDS040	1	25	£17.37

HEIGHT ADJUSTER



Double nozzle

	Code	Pack	Box	£.Each
40mm	WA040D	5	50	£4.84

HEIGHT ADJUSTER



Single nozzle

	Code	Pack	Box	£.Each
40mm	WA040S	5	90	£3.50

Ultimate Flexibility...

Adjustable on both the risers, the tee section and between sink connections, the DBKDS040 gets you out of trouble everytime!

GOOD TO KNOW

WASHING MACHINE TEE



	Code	Pack	Box	£.Each
40mm	WMT001	1	100	£5.00

Can be inserted between existing trap and waste outlet.

32-40mm FLEXIBLE CONNECTOR



	Code	Pack	Box	£.Each
				Length 350mm
	WW170	1	1	£5.16

Not suitable for solvent weld.

1.5M WASHING MACHINE HOSE



	Code	Pack	Box	£.Each
				Non kink hose with support rest supplied
40mm	WW171	1	1	£7.07

Must be fitted in accordance with the appliance manufacturers guidelines.

Multikwik® TRAPS

COMBINED WASTE/OVERFLOW 32mm/40mm

BATH WASTE AND OVERFLOW



Code	Pack	Box	£.Each
40mm CWB01	1	20	£4.66

BATH WASTE AND OVERFLOW



Code	Pack	Box	£.Each
40mm W040F	5	40	£11.98

BATH WASTE AND OVERFLOW



Includes pop up waste

Code	Pack	Box	£.Each
40mm WPU040C	1	5	£49.02

SINK WASTE AND OVERFLOW



Code	Pack	Box	£.Each
40mm CWS01	1	20	£4.02

SINK WASTE AND OVERFLOW



Code	Pack	Box	£.Each
40mm W4070RF	5	40	£13.78

SLOTTED BASIN WASTE OUTLET



Includes polyplug and chain

Code	Pack	Box	£.Each
32mm SBW01	1	40	£9.01

GOOD TO KNOW



Wondering about the Plug Tidy Overflow feature?

Well it retains the plug when the bath is not in use.



Multikwik®

COMPRESSION WASTE

32mm
40mm
50mm

MULTIFLEX BEND



Instantly adjustable from 0 – 90° to meet the demands of almost any installation

Code	Pack	Box	£.Each
32mm MFW32	1	50	£7.50
40mm MFW40	1	50	£7.79

40x22mm CONDENSE ADAPTOR



Adapts to condense line
Fits most sizes of overflow

Code	Pack	Box	£.Each
40mm EB40R	1		£2.80

REDUCER



Code	Pack	Box	£.Each
40/32mm WP124	10	200	£2.86
40mm WP115	1	130	£3.86

STRAIGHT COUPLING



Code	Pack	Box	£.Each
32mm WP114	10	280	£2.29
40mm WP115	10	220	£2.29
50mm WP216	1	90	£3.10

90° BEND



Code	Pack	Box	£.Each
32mm WP120	10	200	£2.57
40mm WP121	10	150	£2.57
50mm WP222	1	112	£3.27

135° BEND



Code	Pack	Box	£.Each
32mm WP126	10	230	£2.57
40mm WP127	10	180	£2.57
50mm WP218	1	70	£3.27

92½° TEE



Code	Pack	Box	£.Each
32mm WP128	10	120	£3.66
40mm WP129	10	80	£3.95
50mm WP230	1	80	£4.12

GOOD TO KNOW



Our compression range is available in 32mm, 40mm & 50mm with coloured slip rings for easy identification.

COMPRESSION WASTE

32mm
40mm

400mm PIPE



C	Code	Pack	Box	£.Each
	32mm WP101C	1		£12.11
	40mm WP102C	1		£12.92

1.1m PIPE



C	Code	Pack	Box	£.Each
	32mm WP105C	1		£25.02
	40mm WP106C	1		£26.64

STRAIGHT COUPLING



C	Code	Pack	Box	£.Each
	32mm WP114C	1		£6.86
	40mm WP115C	1		£7.66

PIPE CLIP



C	Code	Pack	Box	£.Each
	32mm WP141C	3		£4.85
	40mm WP142C	3		£5.65

90° BEND



C	Code	Pack	Box	£.Each
	32mm WP120C	1		£7.66
	40mm WP121C	1		£8.48

92½° TEE



C	Code	Pack	Box	£.Each
	40mm WP129C	1		£12.92

PIPE COVER



C	Code	Pack	Box	£.Each
	32mm WP153C	1		£5.25
	40mm WP154C	1		£6.05

GOOD TO KNOW

For a 'Fit & Forget' job, the thumb recesses make it easy to tighten the joint – even with wet hands!



EASY BOSS

A Simple Connection

From 32mm or 40mm Push-fit or Solvent Weld pipe to anywhere in your 110mm soil stack!

There's no straps which makes it ideal for limited access installations.

And it's installed in 6 really easy steps.



1. Drill a 57mm hole



2. Ensure seal is in position



3. Insert Easy Boss into hole



4. Twist in the Easy Boss connector



5. Use a strap wrench and hand tighten



6. Insert the pipe

110mm EASY BOSS



	Code	Pack	Box	£.Each
Grey	MKEB4032G	1	30	£19.68
Black	MKEB4032B	1	30	£19.68

40x22mm CONDENSE ADAPTOR



Adapts to condense line. Fits most sizes of overflow. remove sleeve first.

	Code	Pack	Box	£.Each
40mm	EB40R	1		£2.80

Use the EB40R and adapt your Easy Boss to accept Overflow pipe.

It's designed to accept pipe from 16.46 to 24.28mm in diameter.

Perfect for condense line!

GOOD TIP Ideas

WC CONNECTORS

STRAIGHT

Selecting your WC Connector

Measure the **INNER** diameter of your pipe



Measure the **OUTER** diameter of your Spigot



Then take a look at the dimensions provided on the individual connectors to find the best matches!

GOOD TIP

LONG ADJUSTABLE STRAIGHT



Spigot 97-108mm Pipe 99-105mm			
Code	Pack	Box	£.Each
MKLA1	1	10	£12.03

STANDARD



Spigot 108-114mm Pipe 99-105mm			
Code	Pack	Box	£.Each
MKS1	5	30	£6.44

STANDARD



Spigot 97-108mm Pipe 99-105mm			
Code	Pack	Box	£.Each
MKS2	3	36	£6.44

GOOD TO KNOW



The Multikwik MKS1 (known as the "No.1") is for old style pans only. If you are installing a new pan always ask for the MKS2!

Make sure you know your pans

97 - 108mm Modern Pans
108 - 114mm Old Pans
76 - 96mm Stainless Steel

STRAIGHT



Spigot 108-114mm Pipe 88-92mm			
Code	Pack	Box	£.Each
MKS3	1	30	£6.44

EXTENDED STRAIGHT



Spigot 97-108mm Pipe 88-92mm			
Code	Pack	Box	£.Each
MKS7	1	30	£6.44

LONG ADJUSTABLE STRAIGHT



Spigot 97-108mm Pipe 99-105mm			
Code	Pack	Box	£.Each
MKLA1	1	10	£12.03

EXTENDED STRAIGHT



Spigot 97-108mm Pipe 99-105mm			
Code	Pack	Box	£.Each
MKS4	1	30	£6.44

EXTENDED STRAIGHT



Spigot 76-95mm Pipe 99-105mm			
Code	Pack	Box	£.Each
MKS8	1	30	£20.76

STRAIGHT WITH BOSS



Spigot 97-108mm Pipe 99-105mm			
Code	Pack	Box	£.Each
MKSB4	1	34	£6.44

STRAIGHT



Spigot 76-95mm Pipe 99-105mm			
Code	Pack	Box	£.Each
MKS5	1	40	£8.66

STRAIGHT SIPHONIC



Spigot 108-114mm Pipe 99-105mm			
Code	Pack	Box	£.Each
MKS1A	1	30	£7.52

STRAIGHT FOR 3" SOIL



Spigot 108-114mm Pipe 74-77mm			
Code	Pack	Box	£.Each
MKS10	1	30	£8.66

WC CONNECTORS

OFFSET

Need an Offset?



Measure from the centre line of your pipe to the centre line of your pan spigot.

Remember, offsets should not be installed in an upwards position. Water should be able to run horizontally or down!

GOOD TO KNOW

18mm OFFSET



Spigot 108-114mm | Pipe 99-105mm

Code	Pack	Box	£.Each
MKO1	5	30	£6.44

18mm OFFSET



Spigot 97-108mm | Pipe 99-105mm

Code	Pack	Box	£.Each
MKO2	1	30	£6.44

18mm OFFSET



Spigot 108-114mm | Pipe 88-92mm

Code	Pack	Box	£.Each
MKO3	1	30	£6.44

18mm OFFSET



Spigot 76-95mm | Pipe 99-105mm

Code	Pack	Box	£.Each
MKO5	1	30	£8.66

18mm OFFSET



Spigot 97-108mm | Pipe 88-92mm

Code	Pack	Box	£.Each
MKO7	1	30	£6.44

18mm OFFSET



Spigot 97-108mm | Pipe 105-108mm

Code	Pack	Box	£.Each
MKO1S	1	30	£8.66

40mm OFFSET



Spigot 97-108mm | Pipe 99-105mm

Code	Pack	Box	£.Each
MKO4	1	30	£6.44

WC CONNECTORS

FLEXIBLE

MULTICLIK – STRAIGHT



Extends from 225 to 550mm

- Flexible ends for excellent joint quality.
- Robust and reliable integral soil sealing fins.
- High quality Multikwik seals.
- Retains its position whatever shape is required.

Spigot 97-108mm | Pipe 99-105mm.

Code	Pack	Box	£.Each
MKC2	3	12	£23.50

MULTICLIK – 90° BEND



Extends from 375 to 710mm

Spigot 97-108mm | Pipe 99-105mm

Code	Pack	Box	£.Each
MKC2B90	1	8	£23.50

Converts a 'P' trap pan into an 'S' trap pan with adjustment and flexibility for final connection.

MULTICLIK – 90° BEND WITH BOSS



Extends from 405 to 740mm

Spigot 97-108mm | Pipe 99-105mm

Code	Pack	Box	£.Each
MKC2BB90	1	8	£27.58

Converts a 'P' trap pan into an 'S' trap pan with adjustment and flexibility for final connection.



GOOD TO KNOW

Sealing Flanges

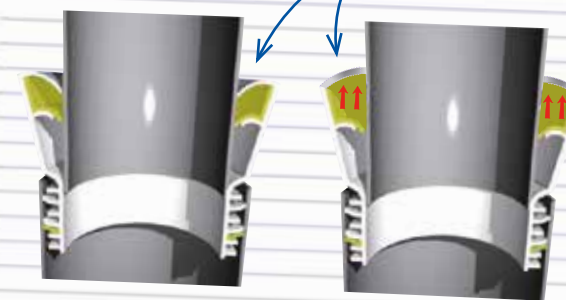

When connecting a WC Connector to the pan spigot the sealing flanges must be pushed inside with the pipe.



Don't pull the other sealing flange out over the top of the pan spigot - it may lead to leaks!

GOOD TO KNOW

Multikwik WC Connectors are made from EVA and are designed to be flexible, so don't worry if your pipe or spigot are not true.

14° BEND



Spigot 97-108mm | Pipe 99-105mm
Code Pack Box £.Each
 MKB114 5 30 £6.87

14° BEND



Spigot 97-108mm | Pipe 105-108mm
Code Pack Box £.Each
 MKB114S 1 30 £20.76

14° BEND



Spigot 76-95mm | Pipe 99-105mm
Code Pack Box £.Each
 MKB514 1 30 £20.76

90° TIGHT KNUCKLE BEND



Spigot 108-114mm | Pipe 99-105mm
Code Pack Box £.Each
 MKB21 1 20 £11.21

90° TIGHT KNUCKLE BEND



Spigot 108-114mm | Pipe 105-108mm
Code Pack Box £.Each
 MKB21S 1 20 £20.76

90° TIGHT KNUCKLE BEND – TALL



Spigot 108-114mm | Pipe 99-105mm
Code Pack Box £.Each
 MKB22 1 15 £11.55

14° BEND



Spigot 76-95mm | Pipe 88-92mm
Code Pack Box £.Each
 MKB614 1 30 £20.76

45° KNUCKLE BEND



Spigot 97-108mm | Pipe 99-105mm
Code Pack Box £.Each
 MKB45 1 25 £9.34

104° BEND



Spigot 97-108mm | Pipe 99-105mm
Code Pack Box £.Each
 MKB21104 1 15 £11.21

90° BEND – TALL



Spigot 97-108mm | Pipe 99-105mm
Code Pack Box £.Each
 MKB3190 3 15 £10.76

90° BEND WITH BOSS – TALL



Spigot 97-108mm | Pipe 99-105mm
Code Pack Box £.Each
 MKBB3190 1 10 £17.64

90° SPACE SAVER BEND



Spigot 97-108mm | Pipe 99-105mm
Code Pack Box £.Each
 MKBAR90 1 12 £12.03

90° BEND



Spigot 97-108mm | Pipe 99-105mm
Code Pack Box £.Each
 MKB2190 5 15 £9.55

90° BEND



Spigot 97-108mm | Pipe 105-108mm
Code Pack Box £.Each
 MKB2190S 1 15 £20.76

90° BEND WITH BOSS



Spigot 97-108mm | Pipe 99-105mm
Code Pack Box £.Each
 MKBB2190 1 15 £16.62

Quality In Built...

British Standard states that a solid ball of 80mm must pass through pipework unaided.

All Multikwik Pan Connectors including those with Boss upstands meet this requirement, reducing the chance of blockage and expensive remedial costs.

GOOD TO KNOW



WC CONNECTORS

EXTENSIONS
& LINKS

SOIL PIPE EXTENSION



Pipe 99-105mm



Code	Pack	Box	£.Each
MKEA	5	20	£5.63

Used either as an extension to a Multikwik Connector or an adaptor to 4" soil pipe.

SOIL PIPE CONNECTION



Pipe 88-92mm

Code	Pack	Box	£.Each
MKEB	5	20	£5.63

Used either as an extension to a Multikwik Connector or an adaptor to 3½" soil pipe.

SOIL PIPE CONNECTION



Pipe 74-77mm

Code	Pack	Box	£.Each
MKEG	1	20	£6.44

Used either as an extension to a Multikwik Connector or an adaptor to 3" soil pipe.

FLUSH PIPE CONNECTOR



Code	Pack	Box	£.Each
MKFPC1	1	50	£0.98

Connects outside diameter 38mm flush pipe to low level or BTW WC Pan.

MULTILINK



Code	Pack	Box	£.Each
MKL1	1	50	£1.65

Sleeves the fins of 99-105mm outlet Multikwik Pan Connectors to enable connection to be made to the inlet of another.

GOOD TIP

Remember all genuine Multikwik WC Connectors are supplied with a sachet of lubricant – except for our rigid and adjustable connectors.



GOOD TO KNOW



Multilink is a unique fitting which sleeves the fins of all 99-105mm outlet Multikwik Pan Connectors.

Enabling direct connection to be made to the inlet of another Pan Connector!



WC CONNECTORS

RIGID

RIGID 18mm OFFSET



Spigot 97-108mm | Pipe 99-105mm

Code	Pack	Box	£.Each
MKRO2	1	31	£6.62

RIGID 14° BEND



Spigot 97-108mm | Pipe 99-105mm

Code	Pack	Box	£.Each
MKRB14	1	31	£6.62

RIGID 90° BEND



Spigot 97-108mm | Pipe 99-105mm

Code	Pack	Box	£.Each
MKRB90	1	15	£8.29

RIGID STRAIGHT



Spigot 97-108mm | Pipe 99-105mm

Code	Pack	Box	£.Each
MKRS2	1	31	£6.62

RIGID 100mm OFFSET



Spigot 97-108mm | Pipe 99-105mm

Code	Pack	Box	£.Each
MKO100	1	20	£17.77

RIGID SOIL PIPE EXTENSION



Spigot 97-108mm | Pipe 99-105mm

Code	Pack	Box	£.Each
MKREXT	1	20	£6.05

Strength built in...

Multikwik sanitary frames will support loads in excess of 400kg (63st) and are designed for a 25 year lifespan.

For versatility and reliability in modern bathroom design, trust the wide Multikwik sanitary systems range.

GOOD TO KNOW



SANITARY SYSTEMS

ECONOMY & COMPACT CONCEALED CISTERNS

Reliable, high quality and simple to install. Our range offers both, price and size flexibility, helping you to complete your project on time and in budget.



ECONOMY SIDE FILL

500(w) x 317(h) x 160mm(d).

- Supplied with Multiflush, Fill Valve and Flush Pipe.
- Suitable for 6 litre applications but also capable of replacing 9 litre applications.
- MFV2C flush valve and 3VALVESIDE included.



Code	Pack	Box	£.Each
TRC1820	1	1	£66.22

CISTERN



- Front or top access

Code	Pack	Box	£.Each
TRV1820	1	1	£118.52

ECONOMY BOTTOM FILL

500(w) x 317(h) x 160mm(d).

- Supplied with Multiflush, Fill Valve and Flush Pipe.
- Suitable for 6 litre applications but also capable of replacing 9 litre applications.
- MFV2C flush valve and 3VALVEBOTTOM included.



Code	Pack	Box	£.Each
TRC1821	1	1	£66.22

SANITARY SYSTEMS

VALVES

MULTIFLUSH VALVE



Standard 1½" outlet – 340mm cable

Code	Pack	Box	£.Each
MFV1C	1	10	£23.86

MULTIFLUSH VALVE



Standard 1½" outlet – 800mm cable

Code	Pack	Box	£.Each
MFV2C	1	10	£28.88

MULTIFLUSH VALVE



Large 2" outlet – 340mm cable

Code	Pack	Box	£.Each
MFV3C	1	10	£27.62

MULTIFLUSH VALVE



Large 2" outlet – 800mm cable

Code	Pack	Box	£.Each
MFV4C	1	10	£32.66

GOOD TO KNOW



A range of compatible buttons and flushplates is available.

See pages 129-134 for details!



SANITARY SYSTEMS

PROTEUS WITH BUTTON

400(w) x 330(h) x 143mm(d)



Cable operation

- Choice of 6/3 or 4/2 litre flush applications.
- Supplied with 500mm cable.
- Cable operation.

Code	Pack	Box	£.Each
TRC1830	1	1	£78.88



PROTEUS benefits include:

- Reduced noise level and condensation.
- Installation options, including front and rear fixing.
- Front and top maintenance access.
- Increased flow rate and bowl cleaning.
- Innovative WRAS approved components.
- Up to 30% water saving with dual flush.
- Tested to 200,000 flushes.
- Supplied pre-set and ready to go.
- Available in pneumatic or cable operation with a wide range of compatible buttons and flush plates.



SANITARY SYSTEMS

FRAMES

WC FRAME



Cistern
"WRAS
Approved"

Code	Pack	Box	£.Each
820mm TRM1820	1	1	£291.66
1000mm TRM1985	1	1	£291.66
1200mm TRM1200	1	1	£291.66

SUPPORT PANEL SPECIAL NEEDS



Code	Pack	Box	£.Each
1200mm TRM6001	1	1	£205.80
1200mm TRM6002	1	1	£205.80

WC FRAME SPECIAL NEEDS



Cistern
"WRAS
Approved"

Code	Pack	Box	£.Each
1185mm TRM1201	1	1	£291.66

WASH BASIN FRAME



Code	Pack	Box	£.Each
820mm TRM2820	1	1	£193.11
985mm TRM2985	1	1	£193.11
1200mm TRM2000	1	1	£193.11

WC FRAME PLUS FLUSHPLATE



Cistern
"WRAS
Approved"

Code	Pack	Box	£.Each
820mm TRM1821	1	1	£276.98

ECLIPSE DUAL FLUSH PLATE



Removable/ interchangeable

Code	Pack	Box	£.Each
White TRF0400E	1	1	£37.30

ECLIPSE DUAL FLUSH PLATE



Removable/ interchangeable

Code	Pack	Box	£.Each
Chrome TRF0427E	1	1	£55.94

ECLIPSE DUAL FLUSH PLATE



Removable/ interchangeable

Code	Pack	Box	£.Each
Satin TRF0428E	1	1	£55.94

SOLAR DUAL FLUSH PLATE



Removable/ interchangeable

Code	Pack	Box	£.Each
Chrome TRF0427S	1	1	£55.94

SOLAR DUAL FLUSH PLATE



Removable/ interchangeable

Code	Pack	Box	£.Each
Satin TRF0428S	1	1	£55.94

CRESCENT DUAL FLUSH PLATE



Removable/ interchangeable

Code	Pack	Box	£.Each
White TRF0400C	1	1	£37.30

ECLIPSE DUAL FLUSH PLATE



Recessed

Code	Pack	Box	£.Each
White TRF1201E	1	1	£78.75
Chrome TRF1202E	1	1	£78.75

ECLIPSE DUAL FLUSH PLATE



Glass

Code	Pack	Box	£.Each
White TRF1215E	1	1	£367.50
Black TRF1216E	1	1	£367.50

ECLIPSE EDUCATION DUAL



Code	Pack	Box	£.Each
Blue TRF1223E	1	1	£55.94

CRESCENT DUAL FLUSH PLATE



Removable/ interchangeable

Code	Pack	Box	£.Each
Chrome TRF0427C	1	1	£55.94

CRESCENT DUAL FLUSH PLATE



Stainless steel.

Removable/ interchangeable

Code	Pack	Box	£.Each
St/Std TRF0433C	1	1	£139.83

ROUND BUTTON



Code	Pack	Box	£.Each
Chrome MFVB6B	1	1	£7.26

ECLIPSE EDUCATION DUAL



Code	Pack	Box	£.Each
Red TRF1224E	1	1	£55.94

ECLIPSE EDUCATION DUAL



Code	Pack	Box	£.Each
Yellow TRF1225E	1	1	£55.94

ECLIPSE EDUCATION DUAL



Code	Pack	Box	£.Each
Green TRF1226E	1	1	£55.94

DUAL MULTIFLUSH BUTTON



Code	Pack	Box	£.Each
Oval MFVB1B	1	1	£6.37

TOILET SEATS

WEY TOILET SEAT



Stainless steel hinges.
Bevelled back style

Code	Pack	Box	£.Each
MKKN002	1	1	£33.43

HAMBLE TOILET SEAT



Long-life stainless steel hinges.
Bevelled contoured front

Code	Pack	Box	£.Each
MKKN003	1	1	£31.57

MOORS TOILET SEAT



High quality anti-bacterial material.
Long-life stainless steel hinges

Code	Pack	Box	£.Each
MKKN004	1	1	£43.56

WC SEAT



Soft Close

Code	Pack	Box	£.Each
MKKN007	1	1	£104.29

EDUCATION WC SEAT



	Code	Pack	Box	£.Each
White	MKKN006	1	1	£124.74
Yellow	MKKN005	1	1	£124.74
Blue	MKKN008	1	1	£124.74
Green	MKKN009	1	1	£124.74
Red	MKKN010	1	1	£124.74

Kwiknut...



GOOD TO KNOW
All Multikwik toilet seats* have the 'Kwiknut' feature, so you can place the nut anywhere on the thread and tighten!
Saving up to 38 turns compared to a traditional washer/nut assembly.

* Applies to MKKN001, MKKN002, MKKN003 and MKKN004

FLOOR DRAINAGE

LINNUM SHOWER DRAIN BODY



Body Only

	Code	Pack	Box	£.Each
650mm	L13560	1	1	£235.87
750mm	L13570	1	1	£250.62
950mm	L13590	1	1	£294.84

LINNUM FLOOR GRATE



650mm

	Code	Pack	Box	£.Each
White	L13564	1	1	£125.31
Black	L13563	1	1	£125.31

LINNUM SOFT FLOOR GRATE



	Code	Pack	Box	£.Each
650mm	L13565	1	1	£51.59
750mm	L13575	1	1	£66.34
950mm	L13595	1	1	£73.72

LINNUM FLOOR GRATE



Elegance

	Code	Pack	Box	£.Each
650mm	L13566	1	1	£58.97
750mm	L13576	1	1	£66.34
950mm	L13596	1	1	£73.72

LINNUM FLOOR GRATE



Square

	Code	Pack	Box	£.Each
650mm	L13567	1	1	£95.83
750mm	L13577	1	1	£110.56
950mm	L13597	1	1	£125.31

LINNUM FLOOR GRATE



Bubble

	Code	Pack	Box	£.Each
650mm	L13569	1	1	£58.97
750mm	L13579	1	1	£66.34
950mm	L13599	1	1	£73.72

LINNUM SHOWER GRID FRAME



Stainless steel

	Code	Pack	Box	£.Each
650mm	TRL428	1	1	£265.36
750mm	TRL429	1	1	£265.36
950mm	TRL430	1	1	£265.36

LINNUM SHOWER CLAMPING FRAME

Use with TRL478



Plastic

	Code	Pack	Box	£.Each
650mm	TRL434	1	1	£58.97
750mm	TRL435	1	1	£58.97
950mm	TRL436	1	1	£58.97

CONTINUOUS CHANNEL



Stainless steel cover

	Code	Pack	Box	£.Each
500mm	L29142	1	1	£221.14

CONTINUOUS CHANNEL



Stainless steel cover Ø50mm Vertical outlet

Code	Pack	Box	£.Each
500mm L29143	1	1	£221.14

CONTINUOUS CHANNEL



Stainless steel cover
Vertical outlet (Ø50mm)
Horizontal outlet (Ø40mm)

Code	Pack	Box	£.Each
150mm L29158	1	1	£103.20

END CAP



With Ø40mm horizontal outlet.

Code	Pack	Box	£.Each
L29036	1	1	£7.37

VERTICAL SHOWER GULLY

Tiled flooring



Body Only

Code	Pack	Box	£.Each
50mm SG50VT	1	1	£30.72
75mm SG75VT	1	1	£30.72

DUAL GRATE & RISER



Code	Pack	Box	£.Each
SG1T	1	1	£46.07

HORIZONTAL SHOWER GULLY



50mm seal depth

Code	Pack	Box	£.Each
ABS SG50WHV	1	1	£71.05
St/st SG50SHV	1	1	£76.79

VERTICAL SHOWER GULLY



50mm seal depth

Code	Pack	Box	£.Each
ABS SG50WVV	1	1	£71.05
St/st SG50SVV	1	1	£76.79

HORIZONTAL SHOWER GULLY



75mm seal depth

Code	Pack	Box	£.Each
ABS SG75WHV	1	1	£71.05
St/st SG75SHV	1	1	£76.79

VERTICAL SHOWER GULLY



75mm seal depth

Code	Pack	Box	£.Each
ABS SG75WVV	1	1	£71.05
St/st SG75SVV	1	1	£76.79

GOOD TO KNOW

Make your installation easier and quicker with the Trapped Shower Gullies for vinyl flooring:

1. Compact

One of the most compact gullies on the market

2. Adaptable

ABS anti-slip or stainless steel lid, horizontal or vertical outlet, 50mm or 75mm seal depth and outlet options of 40mm, 50mm or 110mm – the choice is yours!

3. Secure

Unique locking ring system – for more security!

SQUARE GRATE & RISER



Code	Pack	Box	£.Each
SG2T	1	1	£50.50

CLASSIC GRATE & RISER



Code	Pack	Box	£.Each
SG3T	1	1	£46.07

ANTI-VANDAL GRATE & RISER

Vandal resistant



Code	Pack	Box	£.Each
SG4T	1	1	£46.07

GOOD TO KNOW

Mix and match your shower gullies for tiled flooring:

Pick from one of four gully body options and choose a grate and riser set to match your bathroom style.



SG1T - Two-in-one dual grate



SG4T - Anti-vandal grate

SANITARY SYSTEMS

LINNUM THICKNESS SPACER

For use with Linnum Shower Clamping

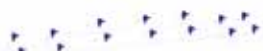

Code	Pack	Box	£.Each
TRL478	1	1	£21.06

CHANNEL SUPPORT SET



Single

Code	Pack	Box	£.Each
TRL426	1	1	£42.12

OUTLET ADAPTORS



S – Solvent C – Compression

	Code	Pack	Box	£.Each
S 40mm	TRL489	1	1	£6.77
S 50mm	TRL488	1	1	£6.77
C 40mm	TRL487	1	1	£21.06
S 50mm	TRL490	1	1	£16.93



GOOD TO KNOW

More spares and ancillaries are available...

Please contact

01622 852 654

for details

www.multikwik.com

Sanitary Systems

MAKE MINE A MULTIKWIK

@Multikwik

www.multikwik.com



The beauty behind bathroom design...

- Wall hung sanitary frames
- Wet room & shower drain solutions
- Concealed cisterns
- Flush plates
- Accessories

For the complete range, turn to page 121



INDEX

RAINWATER PRODUCT INDEX

Product	Page	Product	Page	Product	Page	Product	Page	Product	Page
3SR1520	38	BR320	13	BR521	7	BR920	21	CBR043	27
3SR7601	38	BR371	13	BR521	17	BR921	21	CBR044	27
3SRI125	38	BR373	13	BR522	10	BR922	21	CBR512	25
3SRI22A	38	BR374	12	BR525	13	BR924	21	CBR519	27
3SRS355	38	BR375	12	BR526	13	BR935	20	CBR577	27
3SSI140	38	BR376	12	BR552	5	BR937	20	CBR602	26
3SSI200	38	BR378	11	BR577	7	BR945	20	CBR605	26
BR001	8	BR379	11	BR577	17	BR947	20	CBR607	26
BR003	8	BR380	12	BR578	41	BRV225	39	CBR608	26
BR005	6	BR381	12	BR579	42	BS121	31	CBR610	26
BR006	6	BR383	12	BR602	16	BS208	31	CBR611	26
BR007	6	BR387	11	BR605	15	BS217	31	CBR613	26
BR008	6	BR388	13	BR607	15	BS219	31	CBR615	26
BR010	5	BR389	13	BR608	15	BS220	31	CBR617	26
BR011	5	BR390	13	BR610	15	BS266	32	CBR640	26
BR012	5	BR391	13	BR611	16	BS270	32	DCR300	39
BR013	6	BR392	14	BR613	16	BS271	32	DS024	8
BR014	8	BR393	13	BR615	15	BS309	32	DS042	39
BR014	14	BR394	12	BR617	16	BS322	32	DS500	10
BR014	21	BR395	11	BR640	15	BS331	32	DS500	39
BR017	7	BR396	14	BR666	10	BS334	32	GR001	8
BR017	17	BR397	8	BR682	16	BS336	32	GR002	37
BR019	7	BR397	14	BR700	18	BS403	35	GR004	8
BR019	17	BR398	6	BR705	33	BS404	35	GR004	18
BR020	7	BR399	14	BR707	33	BS406	35	GR005	6
BR020	17	BR400	20	BR708	33	BS412	35	GR007	6
BR021	7	BR400	39	BR710	33	BS424	35	GR008	6
BR021	17	BR402	30	BR711	33	BS425	35	GR009	37
BR022	7	BR451	29	BR713	34	BS427	36	GR009A	37
BR022	17	BR452	29	BR716	34	BS436	36	GR010	5
BR024	8	BR454	29	BR717	18	BS472	36	GR011	5
BR025	5	BR455	29	BR720	18	BS505	31	GR012	5
BR026	37	BR459	6	BR721	18	BS506	31	GR013	6
BR027	37	BR461	6	BR722	18	BS508	31	GR014	8
BR029	9	BR462	6	BR740	33	BS533	35	GR015	37
BR031	9	BR465	32	BR767	39	BS534	35	GR016	37
BR032	9	BR511	5	BR768	8	BS612	18	GR017	7
BR033	9	BR512	5	BR768	39	CBF001	27	GR017	17
BR034	9	BR513	9	BR893	21	CBR005	25	GR018	37
BR036	9	BR515	29	BR896	19	CBR007	25	GR018A	37
BR037	9	BR516	11	BR902	19	CBR008	25	GR019	7
BR038	10	BR517	11	BR908	19	CBR010	25	GR019	17
BR039	10	BR518	7	BR910	19	CBR011	25	GR020	7
BR040	10	BR518	17	BR911	20	CBR013	25	GR020	17
BR041	10	BR519	7	BR913	19	CBR017	27	GR021	7
BR042	29	BR519	17	BR914	19	CBR020	27	GR021	17
BR046	7	BR520	7	BR917	21	CBR021	27	GR022	7
BR046	17	BR520	17	BR919	21	CBR022	27	GR022	17

RAINWATER PRODUCT INDEX

Product	Page	Product	Page	Product	Page	Product	Page	Product	Page
GR025	5	GR613	16	GS534	35	VR033	9	VR520	7
GR029	9	GR615	15	GS535	35	VR034	9	VR520	17
GR031	9	GR617	16	GS570	31	VR036	9	VR521	7
GR032	9	GR640	15	GS571	35	VR037	9	VR521	17
GR033	9	GR666	10	GS612	18	VR038	10	VR522	10
GR034	9	GR682	16	MKRAB	39	VR039	10	VR525	13
GR036	9	GR700	18	R500	6	VR040	10	VR526	13
GR037	9	GR705	33	R500	39	VR041	10	VR577	7
GR038	10	GR707	33	RV195	40	VR046	7	VR577	17
GR039	10	GR708	33	RV196	40	VR046	17	VR602	16
GR040	10	GR710	33	RV369	40	VR301	14	VR605	15
GR041	10	GR711	33	RV482	40	VR320	13	VR607	15
GR042	29	GR713	34	RV491	40	VR370	12	VR608	15
GR046	7	GR716	34	RV637	40	VR371	13	VR610	15
GR046	17	GR717	18	SC950	38	VR373	13	VR611	16
GR377	37	GR720	18	SC953	38	VR374	12	VR613	16
GR398	6	GR721	18	SC954	38	VR375	12	VR615	15
GR402	30	GR722	18	SC960	38	VR376	12	VR617	16
GR410	30	GR740	33	SC961	38	VR378	11	VR640	15
GR410	39	GR909	37	SC966	38	VR379	11	VR682	16
GR451	29	GS121	31	SC967	38	VR380	12	VR700	18
GR452	29	GS208	31	VR001	8	VR381	12	VR717	18
GR454	29	GS217	31	VR005	6	VR383	12	VR720	18
GR455	29	GS219	31	VR006	6	VR387	11	VR721	18
GR465	32	GS220	31	VR007	6	VR388	13	VR722	18
GR511	5	GS264	10	VR008	6	VR389	13	VR893	21
GR512	5	GS266	32	VR010	5	VR390	13	VR896	19
GR513	9	GS270	32	VR011	5	VR391	13	VR902	19
GR515	29	GS271	32	VR012	5	VR392	14	VR908	19
GR518	7	GS309	32	VR013	6	VR393	13	VR910	19
GR518	17	GS322	32	VR014	8	VR394	12	VR911	20
GR519	7	GS331	32	VR014	14	VR395	11	VR913	19
GR519	17	GS334	32	VR014	21	VR396	14	VR914	19
GR520	7	GS336	32	VR017	7	VR397	8	VR917	21
GR520	17	GS403	35	VR017	17	VR397	14	VR919	21
GR521	7	GS404	35	VR019	7	VR398	6	VR920	21
GR521	17	GS406	35	VR019	17	VR399	14	VR921	21
GR522	10	GS412	35	VR020	7	VR400	20	VR922	21
GR577	7	GS420	36	VR020	17	VR400	39	VR924	21
GR577	17	GS424	35	VR021	7	VR511	5	VR927	21
GR600	16	GS425	35	VR021	17	VR512	5	VR935	20
GR601	37	GS427	36	VR022	7	VR513	9	VR937	20
GR602	16	GS436	36	VR022	17	VR516	11	VR945	20
GR605	15	GS472	36	VR024	8	VR517	11	VR947	20
GR607	15	GS505	31	VR025	5	VR518	7	VS612	18
GR608	15	GS506	31	VR029	9	VR518	17	WR001	8
GR610	15	GS508	31	VR031	9	VR519	7	WR005	6
GR611	16	GS533	35	VR032	9	VR519	17	WR006	6



INDEX

RAINWATER PRODUCT INDEX

Product	Page	Product	Page	Product	Page
WR007	6	WR389	13	WR617	16
WR008	6	WR390	13	WR640	15
WR010	5	WR391	13	WR666	10
WR011	5	WR392	14	WR682	16
WR012	5	WR393	13	WR700	18
WR013	6	WR394	12	WR717	18
WR014	8	WR395	11	WR720	18
WR014	14	WR396	14	WR721	18
WR014	21	WR397	8	WR722	18
WR017	7	WR397	14	WR893	21
WR017	17	WR398	6	WR896	19
WR019	7	WR399	14	WR902	19
WR019	17	WR400	20	WR908	19
WR020	7	WR400	39	WR910	19
WR020	17	WR402	30	WR911	20
WR021	7	WR451	29	WR913	19
WR021	17	WR452	29	WR914	19
WR022	7	WR454	29	WR917	21
WR022	17	WR459	6	WR919	21
WR024	8	WR465	32	WR920	21
WR025	5	WR511	5	WR921	21
WR029	9	WR512	5	WR922	21
WR032	9	WR513	9	WR924	21
WR034	9	WR515	29	WR935	20
WR036	9	WR516	11	WR937	20
WR037	9	WR517	11	WR945	20
WR038	10	WR518	7	WR947	20
WR039	10	WR518	17	WS208	31
WR040	10	WR519	7	WS217	31
WR041	10	WR519	17	WS219	31
WR042	29	WR520	7	WS220	31
WR046	7	WR520	17	WS264	10
WR046	17	WR521	7	WS266	32
WR301	14	WR521	17	WS270	32
WR320	13	WR522	10	WS271	32
WR370	12	WR525	13	WS322	32
WR371	13	WR526	13	WS331	32
WR373	13	WR557	11	WS505	31
WR374	12	WR577	7	WS506	31
WR375	12	WR577	17	WS508	31
WR376	12	WR602	16	WS612	18
WR378	11	WR605	15		
WR379	11	WR607	15		
WR380	12	WR608	15		
WR381	12	WR610	15		
WR383	12	WR611	16		
WR387	11	WR613	16		
WR388	13	WR615	15		

PLUMBING PRODUCT INDEX

Product	Page	Product	Page
BP010	63	BS327	55
BP011	63	BS331	47
BP012	64	BS332	47
BP013	64	BS334	49
BP017	63	BS336	49
BP019	63	BS343	53
BP020	63	BS355	56
BP021	63	BS358	56
BP022	64	BS403	46
BP023	64	BS404	47
BP025	64	BS406	46
BP027	63	BS412	51
BP029	63	BS424	48
BP061	63	BS425	48
BP071	63	BS427	49
BP125	63	BS436	48
BP150	63	BS472	55
BS201	47	BS505	45
BS208	46	BS506	45
BS210	46	BS507	45
BS211	46	BS508	45
BS215	52	BS509	45
BS216	52	BS532	45
BS217	51	BS533	45
BS218	52	BS534	45
BS219	51	BS549	45
BS220	51	BS599	45
BS244	52	BS604	46
BS246	55	BS607	51
BS269	49	BS611	49
BS270	48	BS612	51
BS271	48	BS616	55
BS272	49	BS619	46
BS278	50	BS621	47
BS280	55	BS630	48
BS281	55	BS631	48
BS292	49	BS633	54
BS293	46	BS634	56
BS294	47	BS635	56
BS295	50	BS636	54
BS297	49	BS667	55
BS299	47	BS671	46
BS300	50	BS672	49
BS302	49	BS676	48
BS309	55	BS758	53
BS310	55	BS758	68
BS322	46	BW057	67
BS326	55	BW060	65

PLUMBING PRODUCT INDEX

Product	Page	Product	Page	Product	Page	Product	Page	Product	Page
BW061	65	CBS671	61	GS215	52	GS404	47	GS636	54
BW078	66	CBS676	61	GS216	52	GS406	46	GS667	55
BW079	66	CBSV42	62	GS217	51	GS410	46	GS668	54
BW081	67	CC110	60	GS218	52	GS411	54	GS671	46
BW082	67	DS025	54	GS219	51	GS412	51	GS672	49
BW084	67	DS028	71	GS220	51	GS420	54	GS676	48
BW085	67	DSG07	71	GS244	52	GS422	56	GS700	48
BW090	67	DSG10	72	GS246	55	GS424	48	GS751	53
BW091	67	DSG11	72	GS263	48	GS425	48	GS751	64
BW104	53	DSG12	72	GS264	54	GS427	49	GS751	68
BW104	67	DSG16	71	GS269	49	GS436	48	GS758	53
BW105	53	DSG32	71	GS270	48	GS437	53	GS758	68
BW105	68	EB40R	70	GS271	48	GS472	55	GS759	53
BW106	53	GP010	63	GS272	49	GS505	45	GS759	64
BW106	67	GP011	63	GS278	50	GS506	45	GS759	68
BW107	53	GP012	64	GS280	55	GS507	45	GS795	72
BW107	68	GP013	64	GS281	55	GS508	45	GW057	67
BW116	66	GP014	64	GS292	49	GS509	45	GW058	53
BW117	66	GP017	63	GS293	46	GS530	45	GW058	64
BW118	64	GP019	63	GS294	47	GS532	45	GW058	68
BW118	65	GP020	63	GS295	50	GS533	45	GW059	53
BW119	64	GP021	63	GS296	50	GS534	45	GW059	64
BW119	65	GP022	64	GS297	49	GS535	45	GW059	68
BW538	65	GP023	64	GS299	47	GS570	51	GW060	65
BW539	65	GP024	64	GS300	50	GS571	51	GW061	65
BW541	65	GP025	64	GS301	50	GS590	56	GW064	65
BW542	65	GP027	63	GS302	49	GS594	56	GW078	66
BW709	65	GP029	63	GS309	55	GS596	56	GW079	66
BW710	65	GP061	63	GS310	55	GS599	45	GW081	67
BW711	65	GP071	63	GS312	49	GS602	45	GW082	67
BW712	66	GP125	63	GS319	46	GS603	45	GW084	67
BW713	67	GP150	63	GS322	46	GS604	46	GW085	67
BW714	67	GP200	63	GS323	47	GS605	46	GW088	67
BW716	65	GP201	63	GS324	47	GS607	51	GW090	67
BW717	67	GP202	64	GS325	47	GS608	52	GW091	67
BW718	67	GP203	64	GS326	55	GS610	53	GW098	64
BW724	67	GP204	64	GS327	55	GS611	49	GW098	68
CBF001	62	GP205	64	GS329	48	GS612	51	GW099	64
CBS121	61	GP207	63	GS331	47	GS614	50	GW099	68
CBS219	62	GP208	64	GS332	47	GS616	55	GW104	53
CBS220	62	GP210	64	GS334	49	GS618	55	GW104	67
CBS244	62	GP250	63	GS336	49	GS619	46	GW105	53
CBS322	61	GS200	52	GS337	55	GS620	55	GW105	68
CBS331	61	GS201	47	GS343	53	GS621	47	GW106	53
CBS334	62	GS208	46	GS353	68	GS631	48	GW106	67
CBS337	62	GS210	46	GS355	56	GS633	54	GW107	53
CBS508	61	GS211	46	GS358	56	GS634	56	GW107	68
CBS572	62	GS214	54	GS403	46	GS635	56	GW116	66



INDEX

PLUMBING PRODUCT INDEX

Product	Page	Product	Page	Product	Page	Product	Page
GW117	66	WP014	64	WS322	46	WW117	66
GW118	64	WP017	63	WS331	47	WW118	64
GW118	65	WP019	63	WS334	49	WW118	65
GW119	64	WP020	63	WS343	53	WW119	64
GW119	65	WP021	63	WS355	56	WW119	65
GW538	65	WP022	64	WS358	56	WW122	66
GW539	65	WP023	64	WS450	56	WW125	68
GW541	65	WP024	64	WS450	59	WW126	68
GW542	65	WP025	64	WS451	56	WW538	65
GW574	67	WP027	63	WS451	59	WW539	65
GW709	65	WP029	63	WS505	45	WW541	65
GW710	65	WP061	63	WS506	45	WW542	65
GW711	65	WP071	63	WS508	45	WW574	67
GW712	66	WP125	63	WS612	51	WW709	65
GW713	67	WP150	63	WS671	46	WW710	65
GW714	67	WS204	45	WS676	48	WW711	65
GW715	67	WS204	58	WS758	53	WW712	66
GW716	65	WS208	46	WS758	68	WW713	67
GW717	67	WS210	46	WW055	67	WW714	67
GW718	67	WS211	46	WW055	70	WW715	67
GW724	67	WS215	52	WW057	67	WW716	65
GW725	52	WS216	52	WW060	65	WW717	67
GW725	68	WS217	51	WW061	65	WW718	67
MFBSB	48	WS218	52	WW064	65	WW722	67
MFBSG	48	WS219	51	WW078	66	WW723	68
MKUAB	54	WS220	51	WW079	66	WW724	67
MKUAG	54	WS221	57	WW081	67		
MKUAW	54	WS222	58	WW082	67		
QS110	60	WS224	57	WW084	67		
RV591	56	WS225	58	WW085	67		
RV592	56	WS226	57	WW088	67		
RVB592	56	WS227	58	WW090	67		
RVW592	56	WS228	57	WW091	67		
WO220	69	WS234	57	WW099	64		
WO221	69	WS244	52	WW099	68		
WO222	69	WS246	55	WW104	53		
WO223	69	WS248	58	WW104	67		
WO224	70	WS252	58	WW105	53		
WO225	70	WS264	54	WW105	68		
WO226	70	WS269	49	WW106	53		
WO232	69	WS270	48	WW106	67		
WO233	70	WS271	48	WW107	53		
WO245	70	WS291	58	WW107	68		
WO247	69	WS292	49	WW108	66		
WP010	63	WS293	46	WW109	66		
WP011	63	WS294	47	WW113	66		
WP012	64	WS299	47	WW114	66		
WP013	64	WS310	55	WW116	66		

UNDERGROUND PRODUCT INDEX

Product	Page	Product	Page	Product	Page	Product	Page	Product	Page
BS121	80	DS318	76	DS663	78	UCL35SQ	87	UMY21	93
DS001	82	DS322	77	DS670	81	UCLRR	87	UMY22	93
DS002	83	DS326	81	DS671	77	UCR3	87	UMY30	93
DS003	83	DS329	77	DS672	79	UHH16	91	UMY31	93
DS004	83	DS331	77	DS673	76	UHH26	91	UMY32	94
DS006	83	DS342	81	DS674	76	UHH36	91	UMY33	93
DS007	83	DS347	80	DS675	77	ULS13	91	UPH16	91
DS008	83	DS348	80	DS676	77	ULS16	91	UPH26	91
DS010	84	DS350	80	DS678	79	ULS23	91	UPH36	91
DS011	83	DS351	80	DS696	76	ULS33	91	UPS13	91
DS012	82	DS403	77	DS697	76	UMA17	92	UPS16	91
DS020	83	DS404	77	DS728	90	UMA43	94	UPS23	91
DS022	83	DS406	76	DS729	89	UMA45	92	UPS26	91
DS024	80	DS408	76	DS730	89	UMA49	94	UPS33	91
DS025	80	DS409	76	DS731	89	UMB11Q	93	UPS36	91
DS026	80	DS410	76	DS732	89	UMB13Q	93	URP2Q	92
DS027	80	DS411	81	DS733	90	UMB14Q	93	USH16	91
DS028	80	DS418	76	DS734	90	UMB19Q	93	USH26	91
DS039	86	DS421	81	DS735	90	UMB21	93	USH36	91
DS040	86	DS427	79	DS737	90	UMB23	93		
DS046	82	DS428	79	DS738	90	UMB24	93		
DS047	82	DS430	79	DS739	90	UMB29	93		
DS048	82	DS431	77	DS744	89	UMB31	93		
DS049	82	DS432	77	DS752	89	UMB33	93		
DS050	85	DS433	81	DS753	89	UMB34	93		
DS054	82	DS442	81	DS754	89	UMB39	93		
DS055	82	DS471	79	DS755	89	UMD17	92		
DS056	85	DS500	84	DS758	90	UMD27	92		
DS058	85	DS505	75	DS760	90	UME15Q	92		
DS062	85	DS508	75	DS762	90	UME16Q	92		
DS065	85	DS534	75	DS763	90	UME25	92		
DS066	85	DS544	75	DS771	89	UME26	92		
DS066	87	DS545	75	DS773	89	UME35	92		
DS067	85	DS546	75	DS774	89	UME36	92		
DS068	86	DS547	75	DS781	90	UMJ11	92		
DS069	86	DS548	75	GS121	80	UMK11	92		
DS071	86	DS549	75	MFBDO	77	UMK21	92		
DS072	86	DS550	75	MFBSO	77	UMK31	92		
DS075	86	DS555	78	MFYDO	79	UML21	92		
DS076	85	DS556	78	MFYTO	79	UML32	92		
DS208	76	DS557	78	MKEP110	80	UMR150	94		
DS211	76	DS558	78	SC966	94	UMR225	94		
DS212	76	DS559	84	SNC6	94	UMR300	94		
DS214	81	DS560	84	SR160T	94	UMY10Q	93		
DS246	81	DS561	84	SR450	87	UMY11Q	93		
DS269	79	DS563	84	UCC10D	87	UMY12Q	94		
DS278	79	DS566	84	UCC3D	87	UMY13Q	93		
DS309	81	DS633	81	UCL35PP	87	UMY20	93		

MULTIKWIK PRODUCT INDEX

Product	Page	Product	Page	Product	Page	Product	Page
WC CONNECTORS		WC CONNECTORS CONTINUED		PWM040T 106		WP115 110	
MKB114	117			RP032	103	WP115C	111
MKB114S	117	MKS8	114	RP040	103	WP120	110
MKB21	118	MKSB4	114	RP050X	103	WP120C	111
MKB21104	117			S032	103	WP121	110
MKB2190	117			S040	103	WP121C	111
MKB2190S	117			S5040C	104	WP124	110
MKB21S	118			S5040CR	104	WP126	110
MKB22	118			S5040W	104	WP127	110
MKB3190	118			SBK040D	107	WP128	110
MKB45	117			SBSK040	107	WP129	110
MKB514	117			SBW01	109	WP129C	111
MKB614	117			SP032	102	WP141C	111
MKBAR90	118			SP040	102	WP142C	111
MKBB2190	117			ST032	102	WP153C	111
MKBB3190	118			SWM040A	103	WP154C	111
MKC2	116			SWM040D	106	WP216	110
MKC2B90	116			SWM040S	106	WP218	110
MKC2BB90	116			W040F	109	WP222	110
MKEA	119			W4070RF	109	WP225	110
MKEB	119			WA040D	108	WP230	110
MKEG	119			WA040S	108	SANITARY	
MKFPC1	119			WMT001	108	MFV1C	122
MKL1	119			WPU040C	109	MFV2C	122
MKLAS1	114			WV032	105	MFV3C	122
MKO1	115			WV040	105	MFV4C	122
MKO100	120			WW150	106	MFVB1B	126
MKO1S	115			WW151	106	MFVB6B	126
MKO2	115			WW170	108	MKKN002	127
MKO3	115			WW171	108	MKKN003	127
MKO4	115			XSB040S	107	MKKN004	127
MKO5	115			COMPRESSION WASTE		MKKN005	127
MKO7	115			EB40R	110	MKKN006	127
MKRB14	120			MFW32	110	MKKN007	127
MKRB90	120			MFW40	110	MKKN008	127
MKREXT	120			MKEB4032B	112	MKKN009	127
MKRO2	120			MKEB4032G	112	MKKN010	127
MKRS2	120			WP101C	111	TRC1820	121
MKS1	113			WP102C	111	TRC1821	121
MKS10	114			WP105C	111	TRC1830	123
MKS1A	114			WP106C	111	TRF0400C	126
MKS2	113			WP114	110	TRF0400E	125
MKS3	114			WP114C	111	TRF0427C	126
MKS4	114					TRF0427E	125
MKS5	114						
MKS7	114						

MULTIKWIK PRODUCT INDEX

Product	Page	Product	Page
SANITARY CONTINUED		FLOOR DRAINAGE CONTINUED	
TRF0427S	126	L13599	128
TRF0428E	125	L29036	129
TRF0428S	126	L29142	128
TRF0433C	126	L29143	129
TRF1201E	125	L29158	129
TRF1202E	125	SG1T	130
TRF1215E	125	SG2T	130
TRF1216E	125	SG3T	130
TRF1223E	125	SG4T	130
TRF1224E	125	SG50HT	130
TRF1225E	125	SG50SHV	129
TRF1226E	125	SG50SVV	129
TRM1200	124	SG50VT	130
TRM1201	124	SG50WHV	129
TRM1820	124	SG50VVV	129
TRM1821	124	SG75HT	130
TRM1985	124	SG75SHV	129
TRM2000	124	SG75SVV	129
TRM2820	124	SG75VT	130
TRM2985	124	SG75WHV	129
TRM6001	124	SG75VVV	129
TRM6002	124	TRL426	132
TRV1820	121	TRL428	128
FLOOR DRAINAGE		TRL429	128
L13560	128	TRL430	128
L13563	128	TRL434	128
L13564	128	TRL435	128
L13565	128	TRL436	128
L13566	128	TRL478	132
L13567	128	TRL487	132
L13569	128	TRL488	132
L13570	128	TRL489	132
L13571	128	TRL490	132
L13572	128		
L13573	128		
L13574	128		
L13575	128		
L13576	128		
L13577	128		
L13578	128		
L13579	128		
L13580	128		
L13581	128		
L13582	128		
L13583	128		
L13584	128		
L13585	128		
L13586	128		
L13587	128		

NOTES

FIND OUT **MORE**

Do you want to find out more about the following?

- New products
- Future exhibitions and events
- Handy products
- Installation advice
- Latest news
- Case studies

Then follow us on Twitter or go to our website for even more information.

If you can't find what you are looking for or want to give us some feedback then contact us via the email addresses below.



WEBSITE:

www.hunterplastics.co.uk

TWITTER:

@hunterplastics

GET IN TOUCH:

marketing@hunterplastics.co.uk



WEBSITE:

www.multikwik.com

TWITTER:

@multikwik

GET IN TOUCH:

info@multikwik.com

CUSTOMER INFORMATION

PRODUCT INFORMATION

Special lengths

A 5% surcharge will be applied to special lengths of extruded product. Over 250 quality lengths to pro rata price will be charged. (Minimum length 1 metre).

When ordering, please state colour, code & quantity. E.g:

COLOUR	CODE	QUANTITY
B (BLACK)	R10	200

This price list supersedes all previous issues & all prices exclude VAT.

CE MARKING

For the latest copies of the declaration of performance please enter 'Hunter CE Marking' or 'Multikwik CE Marking' into Google™.

PRODUCT PHOTOGRAPHY

Photographs are for representation only and may vary to the actual product. Colours are a guide only.

TRADEMARKS

The following are registered trademarks of Hunter Plastics:

- Hunter
- JOBS A GOOD'UN
- Foundry Finish
- Regency
- Surefit
- Highflo
- Squareflo

The following are registered trademarks of Multikwik:

- Multikwik
- Multiflex
- Multikwik
- Multistop
- Kwiknut

DELIVERY AND COLLECTION

Minimum Order Values

(Carriage Paid) - (UK Mainland Only)

Merchant Yard Deliveries

Orders of £300 net

Site Deliveries

Orders of £750 net (UK Mainland Only)

Collection from Trade Counter

Minimum order value £75 at trade list price.

QUALITY

Quality is one of our core principles:

- Products made with care under ISO9001 & ISO14001 certified system.
- Hunter Plastics products hold many 3rd party approvals, where appropriate these are detailed in the product listing.
- As part of our ongoing quality improvement processes, we reserve the right to alter our products & ranges without notice.

CONDITIONS

All goods are sold according to Hunter Plastics Ltd standard conditions of sale which are available on request.

We make every effort to maintain or reduce costs that are under our control, however fluctuating raw materials and fuel prices have a dramatic effect on our manufacturing costs. We aim to provide you reasonable notice when we implement a price increase, but reserve the right to change prices without prior notice.

© Hunter Plastics Ltd 2016,
All Rights Reserved, E&OE

Sales Hotline: 01622 852654

THE HUNTER PLASTICS PRICE GUIDE

Jam packed with all of the latest above and below ground drainage products from Hunter, including Multikwik, all in one handy book!



JOBS A GOOD'UN™

WWW.HUNTERPLASTICS.CO.UK

[@HUNTERPLASTICS](https://twitter.com/HUNTERPLASTICS)

Sales Hotline
01622 852654

Lenham, Maidstone, Kent, ME17 2DE

WWW.MULTIKWIK.COM

 [@multikwik](https://twitter.com/multikwik)