

9.00

Solvent Soil

Hunter Soil and Waste Systems



9.00 Solvent Soil

9.01

to

9.14 Pipework and sizing

Colours

Black	Grey	Van Dyke Brown	White
●	●	●	●

General colour range - see Hunter Trade Price List or website for specific colour availability.

9.01

Pipe

WASTE SYSTEM PIPE

Plain Ended

Size	Length	Code	A
110mm	1m	S204	-
110mm	2.5m	S579	-
110mm	3m	S505	-
110mm	4m	S506	-

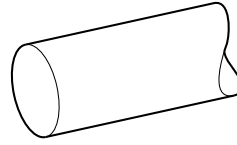

9.02

Double Socket

SOIL SYSTEM DOUBLE SOCKET

Double Socket (Solvent Weld)

Size	Code	A	B
110mm	S210	100	3

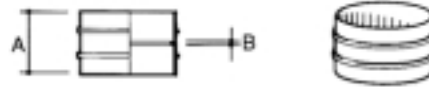

9.03

Bracket

WASTE SYSTEM BRACKET

Pipe

Pipe/Snap Fit - 1 Screw Fixing

Size	Code	A	B	C
110mm	S217	50	90	36

Pipe Bracket - 2 Screw Fixing

Size	Code	A	B	C
110mm	S219	139	91	36

Socket

Size	Code	A	B	C
110mm	S220	158	90	31

Internal Diameter of Ring Pipe Socket Bracket 111mm, Socket Bracket 119mm

Pipe/Socket

Size	Code	A	B	C
110mm	S570	146	90	30

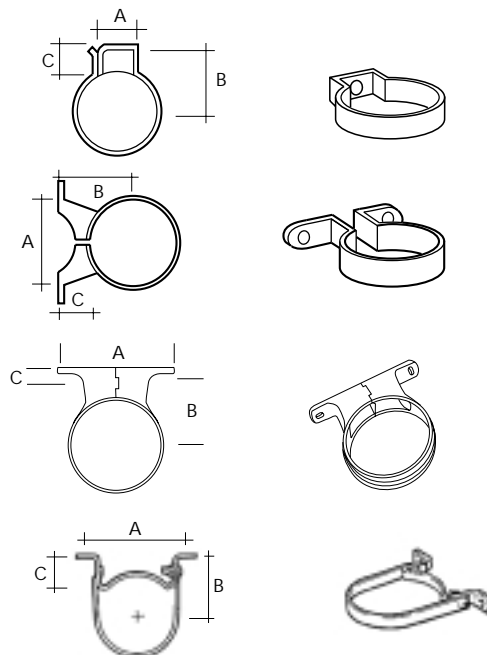

9.04

Bends

WASTE SYSTEM BENDS

Double Solvent Socket

Size	Angle	Code	A	B
110mm	92 1/2°	S293	125	125
110mm	135°	S294	40	70

135° Spigot Tail

Size	Angle	Code	Colours	A	B
110mm	135°	S332	GB	115	-

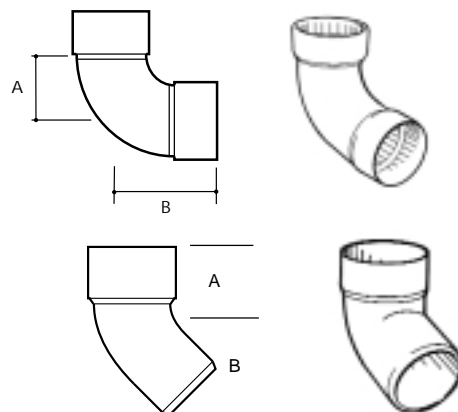

9.04

Bends continued

92 1/2° Long Spigot Tail Solvent Socket

Size	Angle	Code	A	B	C
110mm	92 1/2°	S299	305	162	188

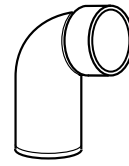
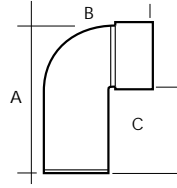

9.05

Offset Bend

WASTE SYSTEM OFFSET BEND

112 1/2° Spigot Tail

Size	Code	A	B
110mm	S271	63	121

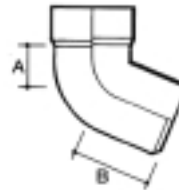

9.06

Access Bend

WASTE SYSTEM ACCESS BEND

92 1/2° Spigot Tail

Size	Code	A	B
110mm	S327	235	94

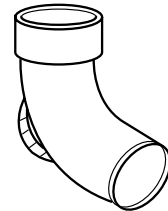
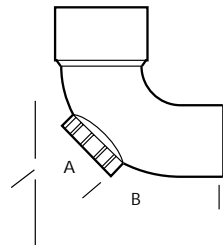

92 1/2° Spigot Tail

Size	Code	A	B
110mm	S330	235	94

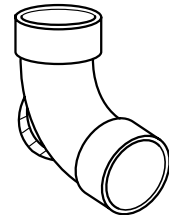
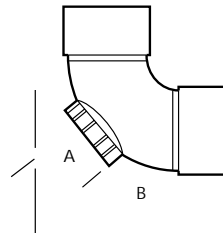

9.07

Branch

WASTE SYSTEM BRANCH

92 1/2° Triple Solvent Socket - 5 Closed Bosses

Size	Code	A	B	C
110mm	S292	85	105	100

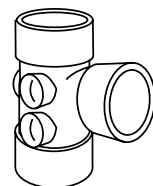
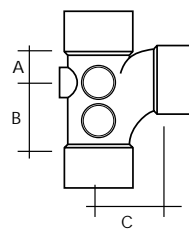

92 1/2° Double Solvent Spigot Tail - 5 Closed Bosses

Size	Code	A	B
110mm	S302	300	205

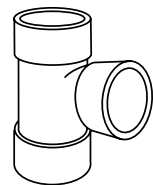
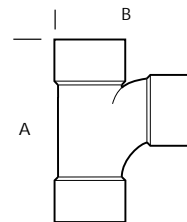

92 1/2° Double Solvent Socket/Spigot Tail - No Bosses

Size	Code	A	B
110mm	S297	300	205

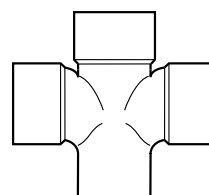

92 1/2° Double Branch Triple Solvent Socket

Size	Code	A	B
110mm	S300	Fabricated	Fabricated

92 1/2° Corner Branch Triple Solvent Socket

Size	Code	A	B
110mm	S301	Fabricated	Fabricated

9.08

Access Branch

WASTE SYSTEM ACCESS BRANCH

92 1/2° Access - No Bosses

Size	Code	A	B
110mm	S280	300	225

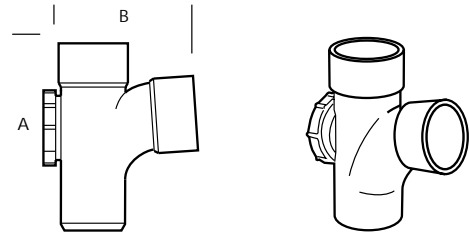

9.09

Access Pipe

WASTE SYSTEM ACCESS PIPE

Double Solvent Socket

Size	Code	A	B
110mm	S310	42	42

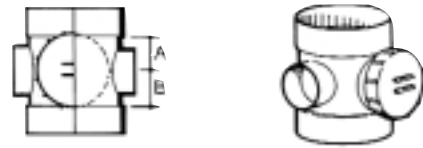

Access Saddle - Direct Fix to Pipework

Size	Code	A
110mm	S337	135



9.10

Access Cap

Access Cap - Spigot Tail

Size	Code	A	B	C
110mm	S246	20	63	125



Access Cap - Solvent Socket Tail

Size	Code	A	B	C
110mm	S667	20	50	125



9.11

Boss Pipe

Short Boss Pipe - Solvent weld

Size	Outlet	Code	A	B
110mm	32mm	S216	125	66
110mm	40mm	S215	125	66
110mm	50mm	S218	125	66

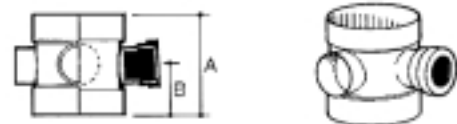

Strap-On-Boss - 50mm open boss

Size	Code	A	B	C
110mm	S343	165	55	50

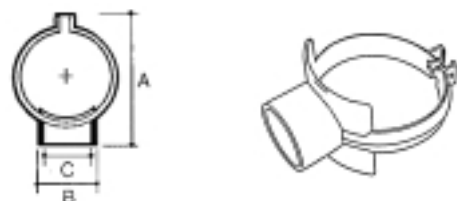

9.12

Reducer

WASTE SYSTEM REDUCER

110mm x 82mm

Size	Code	A	B	C
110/82mm	S636	110	65	82

160mm x 110mm Solvent Socket

Size	Code	A	B	C
160mm	S420	160	68	110

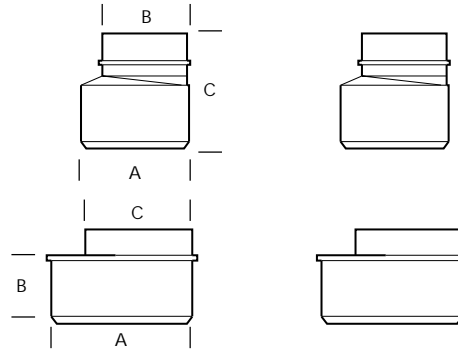

9.13

Expansion Adaptor

WASTE SYSTEM EXPANSION ADAPTOR

Ring Seal Expansion Adaptor

Size	Code	A
110mm	S201	38



9.14

Vent Cowl

WASTE SYSTEM VENT COWL

Vent Cowl

Size	Code	A	B
110mm	S355	48	80

Weathering Collar

Size	Code	A
110mm	S358	60

